

CORE

HEALTH & FITNESS



2024
PRODUCT
CATALOG



A modern fitness studio with a blue color scheme. The room is filled with stationary exercise bikes arranged in rows. The walls are white with blue neon light strips and the text "CONQUER YOUR GOALS" in a glowing blue font. The floor is dark with blue light strips along the edges. The ceiling has several square light fixtures.

CONQUER YOUR GOALS

TABLE OF CONTENTS

1	CORE HEALTH & FITNESS	4
2	STAIRMASTER HIGH INTENSITY	10
	<ul style="list-style-type: none">• StepMills• HIIT Circuit	
3	THROWDOWN	26
	<ul style="list-style-type: none">• Rigs and Storage• FIT Accessories• Free weights• Customization• XTR• Storage• FXD Bench• SSTT• FBR• ABR	
4	NAUTILUS STRENGTH	64
	<ul style="list-style-type: none">• One• Inspiration• Impact• Instinct• HumanSport• Leverage• Plate Loaded• Multi-Stations• Benches• Racks• Customization	
5	STAR TRAC CARDIO	114
	<ul style="list-style-type: none">• 10 Series• 8 Series• 4 Series• S Series	
6	CONNECTED PERFORMANCE	140
	<ul style="list-style-type: none">• OpenHub• Programs• Wexer	
7	WEXER	146
	<ul style="list-style-type: none">• Wexer Virtual• Web Player and App• Wexer SDK/API	
8	SCHWINN GROUP CYCLING	150
	<ul style="list-style-type: none">• Bikes• Console• Customization	
9	INSTRUCTOR EDUCATION	160
10	CUSTOMER SERVICE	166

CORE

HEALTH & FITNESS

At Core, we bring innovative health and fitness brands to the global market. We press into the future of fitness to ensure the creation of quality products and programming that meet the needs of an ever-evolving industry.

SECTION 1



**“OUR PURPOSE
IS TO LIVE AND
SHARE OUR
PASSION FOR
FITNESS”**



CORE

HEALTH & FITNESS



A GLOBAL FITNESS COMPANY

Core Health & Fitness is a global fitness provider. With headquarters in Vancouver, Washington, we have global manufacturing, sales and support with offices in North and South America, Europe, Asia and the Middle East. We understand the importance of a worldwide presence and recognize the benefits of well networked partnerships.

Our promise is to maximize customer delight and trust. It is our job to go above and beyond to create memorable customer experiences and surpass your expectations. We endeavor to create strong relationships and lifelong brand advocates by delivering a world-class customer experience.

VERTICAL INTEGRATION

Core Health & Fitness is a vertically integrated company. Our manufacturing facility in Xiamen, Fujian, China produces our high-end commercial fitness products.

With a focus on financial consolidation, quality control and supply chain integration, we are continually improving operations with the future of the fitness industry at the focal point of our planning.

In addition to manufacturing our own products, Core Health & Fitness is the OEM provider for many top tier brands in the fitness industry. This diverse portfolio has allowed us to expand on manufacturing capabilities while also mitigating risk.

When faced with the COVID-19 pandemic, Core Health & Fitness was able to increase manufacturing volume by pivoting with the increased production of home fitness equipment. This agility, backed by a dedicated and skilled workforce, further exemplifies our continued dedication to producing the best equipment in the industry.

Built in 2003, our facility features over 1M square feet of manufacturing space, research and development laboratories as well as executive and administrative offices. A leading-edge manufacturing area boasts continuous-flow assembly lines, electronic assembly, metal fabrication and weld shops.

The ongoing expansion of development and manufacturing capabilities emphasizes our commitment to continually raise the benchmark for value and quality in fitness and health products and services. Our manufacturing facility implements Continuous-Flow Manufacturing (CFM) and Quality Improvement Programs (QIP), providing continuous product and process improvements.

VIRTUAL INNOVATION CENTER TOUR!

See all that Core Health & Fitness has to offer; scan the QR code and explore our Lake Forest, California Innovation Center



CORE VALUES

PLAY TO WIN

We cultivate employees who want to be part of a team; that are passionate about our industry, our products and our success. We value employees who excel in a fast-paced team environment and that want to play to win.

KEEP SCORE

Do the math, ensuring we are using our time and resources effectively towards a common goal. We believe financial rigor drives our efforts.

OWN IT

We own it from start to finish; we do what we say we will do. If a commitment cannot be met, we communicate and find alternative solutions. We ultimately earn the trust of our partners, achieving the right results.

CHANGE IT UP

We are empowered to change it up. Dynamic environments call for dynamic solutions. We will look for “what’s possible”, not settle for “what is”, and keep moving forward.

ALL IN

We know greatness is not achieved with less than everything we got. As one team, all in together, we strive for breakthrough results and push ourselves to be the best. We are motivated and passionate about our actions and the results.

FIND A WAY

We find a way to create results where others cannot; the words “no” and “failure” are not a part of our vocabulary. We get the job done in spite of any obstacles, and our success is defined by the value we deliver, to our people and our customers.

SPEAK UP

We value your input – Speak up. No idea will ever materialize into success if it remains inside someone’s head. All ideas qualify; best idea wins.
No silent suffering.

An aerial photograph of a lush green forest. A paved road winds through the trees, curving from the top left towards the bottom right. The trees are dense and vibrant green, with some taller, darker green trees interspersed among the lighter green ones. The road is a light grey color, providing a clear path through the forest canopy.

CREATING POSITIVE IMPACT THROUGH THOUGHTFUL ACTION

At Core Health & Fitness our values go beyond a list of ideals. We embrace our humanity and focus on those things we can do to make a positive impact in our local and global communities. We know the past, present and future hold equal weight so we assess our actions and make important choices to assure we leave the world a better place than when we entered.

With focus on Sustainability, Wellbeing and Community, Core Health & Fitness is continually finding ways to strengthen our foundation to share our passion for fitness and our sense of responsibility to protect the future of it.



COMMUNITY

Communities are powered by the human need to connect, and they empower their members to lift each other up. This support particularly from a fitness community crosses all social and physical boundaries.

Our goal is to be the catalyst that brings people together through fitness to accomplish more than they could individually. We meet this goal by participating in events like *Together, We Ride* virtual marathons *Cycle for Survival* and *First Tee YMCA*.



SUSTAINABILITY

The successful growth and resilience of the fitness industry is dependent on meeting the needs of today without compromising the success of future generations.

Core strives to meet this challenge by committing to the United Nations Sustainable Development Goals and follow the Plan-Do-Check-Act framework to become ISO 14001 certified. Our key target areas are to design out waste and pollution in our packaging and to maximize transportation efficiency, as well as actively address welding, injection molding, and assembly processes at the factory that have negative environmental impact.



WELLBEING

At Core, Wellbeing is the pursuit of activities and lifestyle choices that make us physically and mentally healthier, which is both integral to the successful business models of our customers, as well as part of the necessary foundation for our ability as a global team to support those customers effectively.



For more than four decades, StairMaster has been bringing innovation to the human experience in an unmatched workout that delivers results. Through climbing people have connected with StairMaster and Jacobs Ladder to raise their heart rates and burn calories faster with a line-up of products known to be “easier to work harder on.” StairMaster is the workout that everyone loves to hate.

SECTION 2



OWN THE SUMMIT

WHAT WE'RE KNOWN FOR

The #1 name in cardio

High intensity

Reliable products

Delivers quick results

A reputable, trustworthy company





ORIGINAL AND REVOLUTIONARY

The **StairMaster 10G** marks a revolutionary shift in stair-climbing technology. The innovative new design features the OverDrive Training Mode that simulates carrying or pushing a load up stairs, for the most intense climbing workout. The 10G's advancements all focus on delivering the best climbing experience ever created. User-focused features include the widest and deepest stepping surface and lowest step-up height in the industry, ergonomic handrails to support multiple climbing positions and an all new drive train that delivers smooth, quiet performance.

[SEE PAGES 132-137 FOR
CONSOLE DETAILS](#)





8Gx

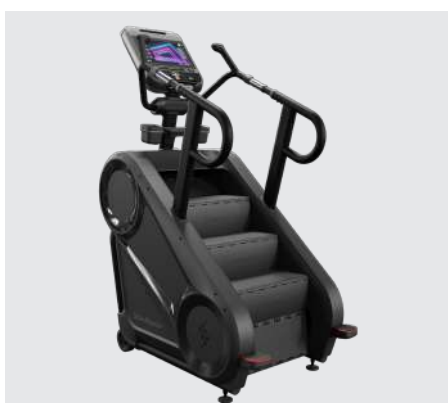

Established in 1983, StairMaster is celebrating 40 years of Killer Cardio. With the introduction of the NEW and IMPROVED 8Gx, StairMaster continues to dominate climbing with the best equipment in the industry.

JLX



The Jacobs Ladder X is designed specifically for training fitness enthusiasts, athletes, and professionals. JLX marks the first major redesign to Jacobs Ladder in over 20 years, and offers four different climbing positions to train different muscle groups at different intensity levels. The JLX also features a redesigned display and dashboard, providing more feedback and information on workout intensity levels based on speed.

4G



Answering the call for a StepMill that can fit into more spaces and reach more users, we are excited to introduce the much anticipated StairMaster 4G. As the newest addition to the StairMaster family, the 4G delivers the same heart-pounding StepMill workout with a great calorie burn through a low-impact stair climb. Designed to fit perfectly into hospitality, boutique, and multi-housing training centers, the 4G has harnessed the quality members have experienced over the past 4 years with the 10G and the recently launched 8Gx. With a footprint of 54" x 29" and a height clearance of only 8 feet, the 4G is the solution this market has been missing.



CONSOLES AND PVS



PVS



LCD



16" EMBEDDED

E G Y M 5 STAR INTEGRATED



CONSOLES AND PVS



PVS



LCD



16" EMBEDDED

E G Y M 5 STAR INTEGRATED

10G

BASE FEATURES	
STEP SURFACE	12in (30 cm) Deep x 22in (56cm) Width
STEP HEIGHT	8in (20cm)
STEP RATE	25 Levels ranging from 24-190 steps per minute
STEP UP HEIGHT	9in (23cm)
RECOMMENDED CEILING HEIGHT	10ft (305cm)
HEART RATE MEASUREMENT SYSTEM	Telemetry and contact HR (Bluetooth with embedded display)
CONTROLS	Easily accessible Hot Bar® is located closer to the user with one-finger speed and elevation controls, integrated stop button and contact heart rate grips
DISPLAY	Choose from LCD or 16" OpenHub display options
ACCESSORIES	Multiple bottle and accessory holders, LCD display pre-wired for 8 Series PVS entertainment, 800/900MHz receivers, and tablet holder
MAX USER WEIGHT	400lb (181kg)
FRAME	
MATERIAL	Powder Coated Steel Frame
CUSTOMIZABLE	Yes, paint color approval required
STANDARD COLOR OPTIONS	Matte Black (-60 black)
LENGTH	63in (160cm)
WIDTH	34in (86cm)
HEIGHT	83in (210cm)
PRODUCT WEIGHT	646lbs (293kg)
SHIPPING DIMENSIONS (BASE + DISPLAY)	59in x 33in x 83in (149cm x 85cm x 210cm)
SHIPPING WEIGHT (BOXED)	818lbs (371kg)

8Gx

BASE FEATURES	
STEP SURFACE	10in (25 cm) Deep x 22in (56cm) Width
STEP HEIGHT	8in (20cm)
STEP RATE	20 Levels ranging from 24-162 steps per minute
STEP UP HEIGHT	9in (23cm)
RECOMMENDED CEILING HEIGHT	10ft (305cm)
HEART RATE MEASUREMENT SYSTEM	Telemetry and contact HR (Bluetooth with embedded display)
CONTROLS	New handrail design features integrated speed and elevation controls, stop button and contact heart rate grips
DISPLAY	Choose from LCD or 16" OpenHub display options
ACCESSORIES	Multiple bottle and accessory holders, LCD display pre-wired for 8 Series PVS entertainment, 800/900MHz receivers, and tablet holder
MAX USER WEIGHT	400lb (181kg)
FRAME	
MATERIAL	Powder Coated Steel Frame
CUSTOMIZABLE	Yes, paint color approval required
STANDARD COLOR OPTIONS	Matte Black (-60 black)
PRODUCT WEIGHT	498lbs (226kg)
SHIPPING DIMENSIONS (BASE + DISPLAY)	52in x 38in x 59in (133cm x 96cm x 150cm)
SHIPPING WEIGHT (BOXED)	611lbs (277kg)



*Light commercial rated

CONSOLES AND PVS



PVS



LCD



10"



EMBEDDED



CONSOLES AND PVS



PVS



LCD



16" EMBEDDED

4G

BASE FEATURES	
STEP SURFACE	10in x 18in (27cm x 46cm)
STEP HEIGHT	6" (15cm)
STEP RATE	20 Levels ranging from 24-162 steps per minute
STEP UP HEIGHT	14in (35.5cm) to first flat step
HEART RATE MEASUREMENT SYSTEM	Telemetry and contact HR (Bluetooth with embedded display)
CONTROLS	Handrail design features integrated speed controls, stop button and contact heart rate grips
DISPLAY	Choose from 10" non-touch, 10" touch or 16" OpenHub display options
ACCESSORIES	Convenient bottle and/or accessory holder, console pre-wired for PVS entertainment
MAX USER WEIGHT	350lb (159KG)
FRAME	
MATERIAL	Powder Coated Steel Frame
CUSTOMIZABLE	Paint color options approval required
STANDARD COLOR OPTIONS	Matte Black (-60)
LENGTH	54in (137cm)
WIDTH	29in (74cm)
HEIGHT	64in (163cm)
PRODUCT WEIGHT	348 LB (158KG)
SHIPPING DIMENSIONS	49in x 30in x 43in (125cm x 76cm x 109cm)
SHIPPING WEIGHT	249LB (113KG)

8-FC FREECLIMBER

BASE FEATURES	
STEP SURFACE	Soft Trac Cushion
STEP HEIGHT	1 to 14in (2.5 to 36cm)
STEP RATE	20 Levels ranging from 24-162 steps per minute
STEP UP HEIGHT	N/A
HEART RATE MEASUREMENT SYSTEM	Telemetry and contact HR (Bluetooth with embedded display)
CONTROLS	Display
DISPLAY	Choose from LCD or 16" OpenHub display options
ACCESSORIES	Multiple bottle and accessory holders, LCD display pre-wired for 8 Series PVS entertainment, 800/900MHz receivers, and tablet holder
MAX USER WEIGHT	350lb (159kg)
FRAME	
MATERIAL	Powder Coated Steel Frame
CUSTOMIZABLE	Yes, paint color approval required
STANDARD COLOR OPTIONS	Matte Black (-60 black)
LENGTH	43in (110cm)
WIDTH	27in (69cm)
HEIGHT	68in (173cm)
PRODUCT WEIGHT	187lbs (85kg)
SHIPPING DIMENSIONS (BASE + DISPLAY)	46in x 30in x 53in (117cm x 76cm x 135cm)
SHIPPING WEIGHT (BOXED)	263lbs (119kg)

E G Y M 5 STAR INTEGRATED



JACOBS LADDER X

BASE FEATURES	
RECOMMENDED CEILING HEIGHT	8.5ft (259cm)
ACCESSORIES	Jacobs Ladder Waist Belt
MAX USER WEIGHT	275LB (125KG)
FRAME	
MATERIAL	Frame: Welded Tubular Steel Rungs: 2" Solid Maple with UV Cured Acrylic Coating Case: ABS Plastic
LENGTH	80in (203cm)
WIDTH	30.5in (77.5cm) (37.25in (95cm) With Removable Cupholders Attached)
HEIGHT	69.5in (177cm)
PRODUCT WEIGHT	345LB (156KG)
SHIPPING DIMENSIONS	32in x 83in x 79in (81cm x 211cm x 201cm)
SHIPPING WEIGHT	422LB (191KG)



JACOBS LADDER 2

BASE FEATURES	
RECOMMENDED CEILING HEIGHT	7.5ft (229cm)
ACCESSORIES	Jacobs Ladder Waist Belt, Stability Bars
MAX USER WEIGHT	275LB (125KG)
FRAME	
MATERIAL	Rungs: Steel Tube with Polyurethane Sleeve Case: ABS/Polyethylene
LENGTH	76in (193cm)
WIDTH	27.25in (69cm)
HEIGHT	65.5in (166cm)
PRODUCT WEIGHT	300LB (136KG)
SHIPPING DIMENSIONS	29in x 77.5in x 71in (74cm x 197cm x 180cm)
SHIPPING WEIGHT	362LB (164KG)

**Light commercial/residential unit only*



JACOBS LADDER

BASE FEATURES	
RECOMMENDED CEILING HEIGHT	7.5ft (229cm)
ACCESSORIES	Jacobs Ladder Waist Belt, Stability Bars
MAX USER WEIGHT	275LB (125KG)
FRAME	
MATERIAL	Frame: Welded Tubular Steel Rungs: Solid Maple Case: ABS/Polyethylene
LENGTH	76in (193cm)
WIDTH	31.25in (79cm)
HEIGHT	65.5in (166cm)
PRODUCT WEIGHT	325LB (147KG)
SHIPPING DIMENSIONS	33.5in x 77.5in x 72in (85cm x 197cm x 183cm)
SHIPPING WEIGHT	357LB (162KG)



STAIRWAY GTL

BASE FEATURES	
RECOMMENDED CEILING HEIGHT	8.5ft (259cm)
MAX USER WEIGHT	275LB (125KG)
FRAME	
MATERIAL	Frame: Welded Tubular Steel Stairs: Steel with Polyvinyl Tread Case: ABS Plastic Handle: Powder-coated Steel Tube
LENGTH	54in (137cm)
WIDTH	30.5in (77cm)
HEIGHT	75.5in (192cm)
PRODUCT WEIGHT	300LB (136KG)
SHIPPING DIMENSIONS	32in x 60in x 82in (81cm x 152cm x 208cm)
SHIPPING WEIGHT	365LB (166KG)

HIIT CIRCUIT

StairMaster® knows what it takes to make the toughest workouts; pioneering the stepmill and taking HIIT to the next level. Our innovative line of HIIT products create a complete circuit that can fit in any space; featuring our HIITMillX, HIIT Rower, HIIT Bike and HIIT UBE. Add our BoxMaster or 10G and you've got the best HIIT circuit available.





HIITMILL AND HIITMILLX



The StairMaster HIITMill and HIITMillX are self-powered speed and strength training tools designed to build explosive power. These High-Intensity machines deliver an effective resistance training platform that captures the benefits of speed and agility training, lateral training and sled training. Users can now push, drive and sprint with the resistance of a sled, safely and with a smaller footprint. Choose the HIITMillX and add Farmer's Carry to that list of capabilities.

HIIT BIKE™



Tested to withstand 1400 LB of force, the StairMaster HIIT Bike™ offers a robust design and features dual action wind resistance that provides a total body cardio workout. The HIIT Bike is designed to push you past your breaking point and keeps working long after you can't.

HIIT UBE™



When it comes to discipline and perseverance, few workouts will challenge you more than those on the Upper Body Ergometer. Whether used in a rehabilitation setting or high performance fitness center, the HIIT UBE adjustable tower, convertible crank arms and comfortable grips let you tailor the workout with the right range of motion for your shoulders, back, wrists, and elbows. An optional ramp and removable bench allows wheelchair access and meets ADA criteria.

HIIT CONSOLE

The StairMaster HIIT console makes great HIIT workouts even more effective. Track your workout with detailed metrics, follow one of the built in workout programs, and connect your phone via Bluetooth to save and share your workout. The console also comes equipped with ANT+ giving you the ability to pair with heart rate trackers and connect to group displays. The HIIT Console comes standard on StairMaster HIIT products.

- Simple, easy to read backlit display
- Easy to use programmable time, distance, calories, time interval, and calorie interval programs
- Bluetooth connectivity to share your information to your favorite tracking app
- Displays heart rate broadcast from ANT+ or 5kHz heart rate straps
- ANT+ allows you to display data on leaderboards with tracking software
- Standard on HIIT Rower, HIITMill, HIITMill X, HIIT Bike & HIIT UBE



HIIT PROGRAMMING



From the makers of the toughest workouts in the gym, comes a tough, engaging and scientifically backed High Intensity Interval Training program. Have your trainers and coaches HIIT certified by our Master Trainers, leverage our unique HIIT products to attract members and learn to market your own exciting HIIT program to create a new source of revenue for your facility.

[SEE PAGES 152-157 FOR MORE ON OUR EDUCATION PROGRAMMING](#)



[THROWDOWN HIIT SKI ROUNDS OUT YOUR HIIT NEEDS! CHECK OUT DETAILS ON PAGES 50-51.](#)

HIIT SKI 9-4710

LENGTH	85 in (216 cm)
WIDTH	20 in (52 cm)
DEPTH	16 in (40 cm)
DRIVE SYSTEM	HMPE Cord
RESISTANCE TECHNOLOGY	Isokinetic fan resistance offers unlimited workout options, while fan dampening system allows for increased or decreased workloads at a given stroke rate
CHAIN OR CORD	Cord
CHAIN/CORD HOUSING	Partially Enclosed
CONSOLE	StairMaster HIIT
MAX USER WEIGHT	350 lbs (159kg)
FRAME CONSTRUCTION	Heavy-gauge welded steel and aluminum construction
COLOR SCHEME	Matte Black
FINISH	Electrostatic Powder Coating for long lasting durability
MACHINE WEIGHT	52 lbs (23 kg)



CONSOLE



HIITMILL® X 9-4680

LENGTH	78 in (197 cm)
WIDTH	55 in (140 cm)
HEIGHT	66 in (167 cm)
RESISTANCE SYSTEM	Magnetic resistance brake with resistance control lever
BELT TYPE	3mm PVC cushioned (compatible with plastic field cleats)
INCLINE RANGE	Fixed 11-degree incline
DECK TYPE	MDF with phenolic coating
RUNNING AREA	23 in Wide
STEP-ON HEIGHT	7.5 in (19 cm)
FARMER'S CARRY LIFT ARMS	Yes
CONSOLE	StairMaster HIIT
POWER REQUIREMENT	Self-powered walking, running and pushing
MAX USER WEIGHT	350 LB (159KG)
WATER BOTTLE HOLDER	Yes
FRAME CONSTRUCTION	Heavy-gauge welded steel construction
COLOR SCHEME	Black and Silver
FINISH	Electro-static powder-coat
MACHINE WEIGHT	441LB (220 KG)
SHIPPING DIMENSIONS	40.94 in x 82.3 in x 33.86 in (104 cm x 209 cm x 86 cm)
SHIPPING WEIGHT	553 LB (251 KG)



CONSOLE



HIITMILL® 9-4670

LENGTH	78 in (197 cm)
WIDTH	38 in (95 cm)
HEIGHT	66 in (167 cm)
RESISTANCE SYSTEM	Magnetic resistance brake with resistance control lever
BELT TYPE	Multi-ply maintenance free
INCLINE RANGE	Fixed 11-degree incline
DECK TYPE	MDF with phenolic coating
RUNNING AREA	23 in Wide
STEP-ON HEIGHT	7.5 in (19 cm)
FARMER'S CARRY LIFT ARMS	No
CONSOLE	StairMaster HIIT
POWER REQUIREMENT	Self-powered walking, running and pushing
MAX USER WEIGHT	350 LB (159KG)
WATER BOTTLE HOLDER	Yes
FRAME CONSTRUCTION	Heavy-gauge welded steel construction
COLOR SCHEME	Black and Silver
FINISH	Electro-static powder-coat
MACHINE WEIGHT	382 LB (173 KG)
SHIPPING DIMENSIONS	40.94 in x 82.3 in x 33.86 in (104 cm x 209 cm x 86 cm)
SHIPPING WEIGHT	494 LB (224 KG)



CONSOLE



HIIT BIKE 9-4650

LENGTH	51 in (130 cm)
WIDTH	29 in (74 cm)
HEIGHT	58 in (147 cm)
RESISTANCE TECHNOLOGY	Dual action wind resistance
SEAT	Airfit Saddle
SEAT ADJUSTMENT	Height - pop pin, Fore/Aft - micro-adjustment
PEDAL SYSTEM	Morse Taper
WATER BOTTLE HOLDER	Yes
COLOR SCHEME	Wrinkle Black
FRAME CONSTRUCTION	Heavy-gauge welded steel construction
FINISH	Electro-static powder-coat
CONSOLE	StairMaster HIIT
POWER REQUIREMENT	NA
MAX USER WEIGHT	350 LB (159KGs)
USER HEIGHT RANGE	4 ft 11 in to 6 ft 8 in (150 to 203 cm)
MACHINE WEIGHT	146 LB (66KG)
SHIPPING DIMENSIONS	50 in x 21 in x 27 in (127 cm x 53 cm x 68 cm)
SHIPPING WEIGHT	168 LB (76 KG)



CONSOLE



HIIT UBE 9-4660

LENGTH	70 in (178 cm)
LENGTH WITHOUT RAMP	48 in (121 cm)
WIDTH	36 in (92 cm)
HEIGHT	Up to 73 in (178 cm)
SEAT	Removable bench for seated or standing workouts
RESISTANCE LEVELS	Dual action wind resistance
TRANSMISSION	Twin belt transmission
TRANSPORT WHEELS	Yes
CONSOLE	StairMaster HIIT
POWER REQUIREMENT	NA
MAX USER WEIGHT	350 LB (159 KG)
WATER BOTTLE HOLDER	Yes
FRAME CONSTRUCTION	Heavy-gauge welded steel construction
COLOR SCHEME	Silver
FINISH	Electro-static powder-coat
STORAGE	Removable bench storage
MACHINE WEIGHT	320 LB (145 KG)
SHIPPING DIMENSIONS	31in x 59in x 42in (79cm x 150cm x 107cm)
SHIPPING WEIGHT	388 LB (176 KG)

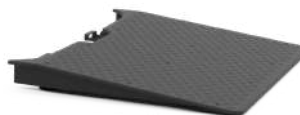

OPTIONAL RAMP 718-5637-26



CONSOLE



HIIT ROWER 9-4690

LENGTH	96 in (244 cm)
WIDTH	26.5 in (68 cm)
SEAT HEIGHT	14 in (35 cm)
MONORAIL LENGTH	53.7 in (137 cm)
DRIVE SYSTEM	Nickel plated steel chain
RESISTANCE TECHNOLOGY	Isokinetic fan resistance offers unlimited workout options, while fan dampening system allows for increased or decreased workloads at a given stroke rate
CHAIN OR CORD	Nickel-Plated Steel Chain
CHAIN/CORD HOUSING	Partially Enclosed
CONSOLE	StairMaster HIIT
MAX USER WEIGHT	350 LB (159KG)
WATER BOTTLE HOLDER	Yes
FRAME CONSTRUCTION	Heavy-gauge welded steel and aluminum construction
COLOR SCHEME	Wrinkle Black
FINISH	Electrostatic Powder Coating for long lasting durability
STORAGE	Disconnecting at center point
MACHINE WEIGHT	82 LB (37 KG)
SHIPPING DIMENSIONS	22 in x 57 in x17 in (56 cm x 145 cm x 43 cm)
SHIPPING WEIGHT	90 LB (41 KG)

HIIT CONSOLE

DISPLAY TYPE	Fixed Segment LCD
DISPLAY AREA	13.8in ²
BACKLIGHT	Yes
# METRICS DISPLAYED	5
# PROGRAMS	5
CUSTOM PROGRAMS	5 (Time, Distance, Calories, Time Interval, Calorie Interval)
POWER REQUIREMENT	Power two C cell batteries or an optional external power supply can be ordered
5 GHZ HEART RATE	Yes
ANT+ HEART RATE	Yes
ANT+ L. BOARD SIGNAL	Yes
BLE CONNECTIVITY	Yes
MULTI-LANGUAGE OPTIONS	No
QUICK START OPTIONS	Yes
BLUETOOTH DATA TRACKING	Yes
USB SOFTWARE UPLOAD	Yes



BOXMASTER PRO 9BM-K9601

HEIGHT	82 in (208 cm)
WIDTH	33 in (84 cm)
LENGTH	30 in (76 cm)
# STRIKING PADS	12
# TOWERS	1
USER HEIGHT RANGE	5 ft to 6 ft 10 in (152.4 cm to 208 cm)
MAX USER WEIGHT	NA
KICK PAD OPTION	Yes
FRAME CONSTRUCTION	Heavy-gauge welded steel construction
COLOR SCHEME	Black/Red
MACHINE WEIGHT	222 LB (100 KG)
SHIPPING DIMENSIONS	20in x 70in x 21in (51cm x 178cm x 53cm)
SHIPPING WEIGHT	246 LB (112 KG)



OPTIONAL BASEPLATE 400-1120



OPTIONAL KICK PAD 731-5674



BOXMASTER PRO QUAD 9BM-K9604

HEIGHT	82 in (208 cm)
WIDTH	75 in (185 cm)
LENGTH	73 in (183 cm)
# STRIKING PADS	12
# TOWERS	4
USER HEIGHT RANGE	5 ft to 6 ft 10 in (152.4 cm to 208 cm)
MAX USER WEIGHT	NA
KICK PAD OPTION	Yes
FRAME CONSTRUCTION	Heavy-gauge welded steel construction
COLOR SCHEME	Black/Red
MACHINE WEIGHT	1214LB (551 KG)
SHIPPING DIMENSIONS	88in x 88in x 44in (224cm x 224cm x 112cm)
SHIPPING WEIGHT	1293 LB (586 KG)



OPTIONAL KICK PAD 731-5674

NEW



EDUCATION STAND 9-BMES-60ENG

The Education Stand has been designed to make the whole boxing experience easy and fun for beginners and also provide dynamic workouts for the more experienced. There are 3 QR Codes for varying experiences giving you multiple options when working out.

HEIGHT	58.7 in (1492 mm)
WIDTH	15.7 in (400 mm)
LENGTH	15.7 in (400 mm)

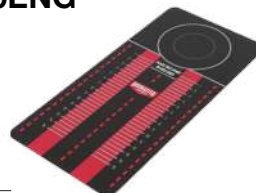

STANCE MAT 731-9445

This Stance Mat has been designed to simplify a difficult problem when learning the basics of boxing, balance and foot placement. We at Boxmaster have taken the guess work out of it, whether you have a southpaw or orthodox stance, simply place your feet on the lines, fully extend your arms so they make contact with the pads, bend your knees, hands up, chin down and you're good to go.

HEIGHT	.12 in (3 mm)
WIDTH	51 in (1295 mm)
LENGTH	106 in (2692 mm)



THROWDOWN[®]

PUSHING BOUNDARIES

For 20 years, Throwdown has offered unique workout opportunities that add diversity and challenge to any exercise routine. From functional training zones to boxing, mixed martial arts and more, Throwdown products are the differentiator in any facility.

SECTION 3



PUSHING BOUNDARIES

WHAT WE'RE KNOWN FOR

Reliable products

Engaging, flexible workouts

The equipment used by serious athletes



FUNCTIONAL IMPACT TRAINING





ALPHA XTC RIG SERIES

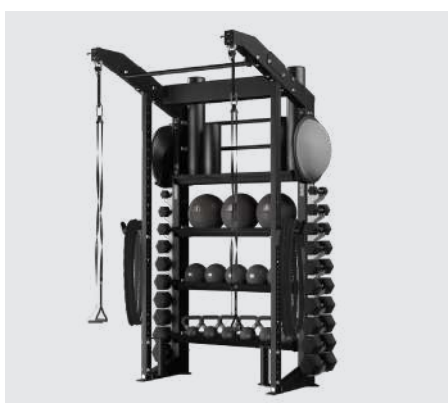

The Alpha XTC Rigs maximize your valuable training space while optimizing your facilities ability to offer the programming that fits members' needs. With built-in suspension points and the ability to add Olympic squat stations, the Alpha XTC is the perfect solution whether you're looking to add or enhance your personal or small group training offerings.

XTC STANDARD AND COMPACT RIGS



The XTC is a hyper flexible rig, carefully engineered to create training zones for groups of members to train simultaneously. Constructed with 4' cross member bars, the XTC comes available in both Standard and Compact configurations to accommodate various spaces and group sizes. With a variety of station attachments, the XTC rigs are ideal for functional training.

CUSTOMIZATION



Your space is unique, your members and trainers have specific needs. You have a brand that needs to be represented throughout your facility. Throwdown can meet and exceed your expectations. Our XTC Rigs are hyper flexible and carefully engineered so that they may be configured to fit the space and training programs designed by your instructors.

ALPHA XTC RIGS



**Accessories not included*

FUNCTIONAL STRENGTH STATION 9-WR1-60THD

LENGTH	60 (153 CM)
WIDTH	54 in (139 cm)
HEIGHT	105 in (268 cm)
RECOMMENDED FLOOR SPACE	14' x 14' (4.27m x 4.27m)
CONSTRUCTION	11-gauge steel, 3"x6" (7.5cm x 15cm) tubing
FINISH	Electrostatic Powder coating



**Accessories not included*

FUNCTIONAL CORE STATION 9-WR2-60THD

LENGTH	69 in (175 cm)
WIDTH	56 in (144 cm)
HEIGHT	105 in (268 cm)
RECOMMENDED FLOOR SPACE	14' x 14' (4.27m x 4.27m)
CONSTRUCTION	11-gauge steel, 3"x6" (7.5cm x 15cm) tubing
FINISH	Electrostatic Powder coating



PERSONAL TRAINING CENTER 9-PTC-60THD

LENGTH	290 in (737 cm)
WIDTH	235 in (598 cm)
HEIGHT	105 in (267 cm)
RECOMMENDED FLOOR SPACE	24' x 26' (7.3 x 7.9 m)
CONSTRUCTION	11-gauge steel, 3"x6" (7.5cm x 15cm) tubing
FINISH	Electrostatic Powder coating

ALPHA XTC ADD ONS

CUSTOM COLORS



4' CORE 73-00221-60

LENGTH	46 in (116 cm)
WIDTH	48 in (123 cm)
HEIGHT	105 in (267 cm)
CONSTRUCTION	11-gauge steel, 3"x6" (7.5cm x 15cm) tubing
FINISH	Electrostatic Powder coating



4' ADD-ON 73-00190-60

LENGTH	46 in (116 cm)
WIDTH	45 in (118 cm)
HEIGHT	105 in (267 cm)
CONSTRUCTION	11-gauge steel, 3"x6" (7.5cm x 15cm) tubing
FINISH	Electrostatic Powder coating



20' BRIDGE 73-00222-60

LENGTH	225 in (572 cm)
WIDTH	57 in (146 cm)
HEIGHT	105 in (267 cm)
CONSTRUCTION	11-gauge steel, 3"x6" (7.5cm x 15cm) tubing
FINISH	Electrostatic Powder coating



16' BRIDGE 73-00223-60

LENGTH	177 in (450 cm)
WIDTH	57 in (146 cm)
HEIGHT	105 in (267 cm)
CONSTRUCTION	11-gauge steel, 3"x6" (7.5cm x 15cm) tubing
FINISH	Electrostatic Powder coating



BLACK -60



SILVER -29



KARMINROT -30



ULTRAMARINE BLUE -73

We know what it takes to build an authentic, meaningful brand experience. Our customization program is the perfect way to leverage your personal brand and make a strong first impression. Get Throwdown Alpha XTC Rigs in a variety of custom color options.

ALPHA XTC BRIDGE ATTACHMENT



BAG HANGER
SKU: 73-00158-60-KT



PULL UP BAR ADD-ON
SKU: 73-00192-60-KT

ALPHA XTC POST ATTACHMENTS



WIDE SHELF, 4'
SKU: 52-00124-60-KT



WIDE SHELF, 6'
SKU: 52-00125-60-KT



STABILITY BALL SHELF, 6'
SKU: 52-00156-60-KT



PLATE STORAGE, 4'
SKU: 71-00363-60-KT



STORAGE BIN, 4'
SKU: 71-00402-60-KT

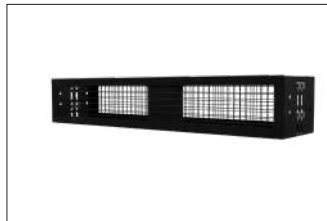

STORAGE BIN, 6'
SKU: 52-00127-60-KT



PLATE STORAGE, 4'
SKU: 71-00363-60-KT



PLATE STORAGE, 6'
SKU: 73-00242-60-KT



LOCKING DRAWER, 42"
SKU: 73-00267-60-KT



LOCKING DRAWER, 4'
SKU: 73-00268-60-KT



LOCKING DRAWER, 6'
SKU: 73-00269-60-KT



DRAWER TOPPER SHELF, 42"
SKU: 73-00279-60-KT



DRAWER TOPPER SHELF, 4'
SKU: 73-00280-60-KT



DRAWER TOPPER SHELF, 6'
SKU: 73-00266-60-KT

ALPHA XTC POST ATTACHMENT

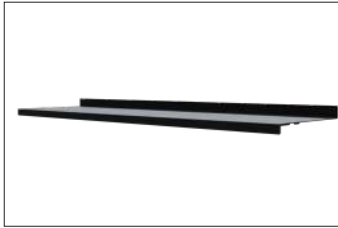

PLYO SHELF
SKU: 52-00158-60-KT

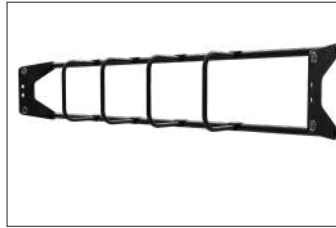

ROLLER STORAGE KIT, 6'
SKU: 73-00197-60-KT

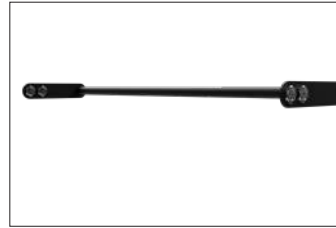

ROLLER CONTAINMENT, 4'
SKU: 73-00196-60-KT

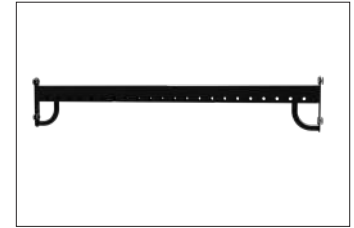

XTC CROSSMEMBER, 6'
SKU: 52-00114-60-KT

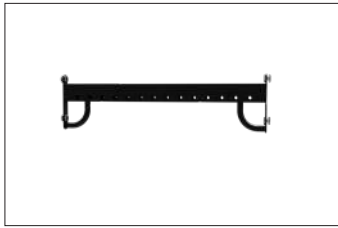

XTC CROSSMEMBER, 4'
SKU: 52-00113-60-KT



STORAGE PIN
SKU: 52-00139-60-KT



STORAGE PEG
SKU: 71-00357-60-KT



BARBELL STORAGE
SKU: 73-00239-60-KT



BALANCE BALL
SKU: 73-00191-60-KT



**WEIGHT PLATE
STORAGE HANGER**
SKU: 73-00162-60-KT

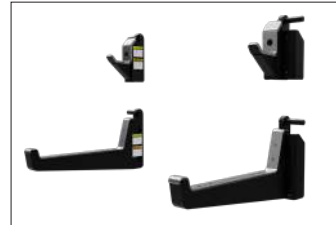

SQUAT STATION
SKU: 73-00151-60-KT



ATTACHMENT POINT
SKU: 72-00108-60-KT



LANDMINE RIG MOUNT
SKU: 71-00227-60-KT



BAR STORAGE
SKU: 71-00267-60-KT



ROPE ANCHOR RIG MOUNT
SKU: 71-00308-60-KT

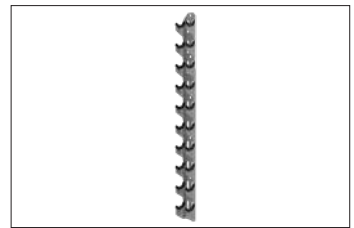

VERTICAL DUMBBELL RACK
SKU: 71-00367-29-KT



ROPE HANGER, PTC
SKU: 73-00194-60-KT

XTC STANDARD RIGS



XTC 4X14 STANDARD 9-XTC-414C-60THD

RECOMMENDED FLOOR SPACE	14' X 24' (4.26 X 7.32M)
INCLUDES:	
BALL SHELF, 4' X4	STORAGE PIN X4
BAR STORAGE X2	SQUAT STATION, 4' X2
PLATE STORAGE, 4' X2	TARGET + DPU ADAPTER X2
LANDMINE, RIG MOUNT X2	VERTICAL DUMBBELL RACK X2
ROPE ANCHOR, RIG MOUNT X2	WIDE SHELF, 4' X2
STORAGE BIN, 6' X1	XTC CROSSMEMBER, 6' X1



XTC 4X24 STANDARD 9-XTC-424C-60THD

RECOMMENDED FLOOR SPACE	14' X 34' (4.26 X 10.36M)
INCLUDES:	
BALL SHELF, 4' X4	ROPE ANCHOR, RIG MOUNT X2
BAR STORAGE X2	STORAGE BIN, 6' X2
DIP BAR X2	STORAGE PIN X8
LANDMINE, RIG MOUNT X2	SQUAT STATION, 4' X2
MEGA GRIP PULLUP BAR, 4' X1	TARGET + DPU ADAPTER X2
MUSCLE UP ATTACHMENT X1	VERTICAL DUMBBELL RACK X2
NEUTRAL GRIP PULLUP X2	WIDE SHELF, 4' X6
PLATE STORAGE, 4' X2	XTC CROSSMEMBER, 6' X2

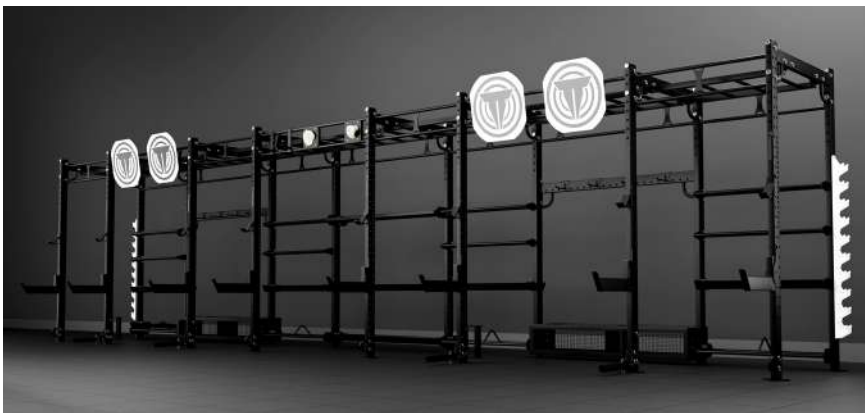

XTC 4X34 STANDARD 9-XTC-434C-60THD

RECOMMENDED FLOOR SPACE	14' X 44' (4.26 X 13.41M)
INCLUDES:	
BALL SHELF, 4' X8	STORAGE PIN X8
BAR STORAGE X4	SQUAT STATION, 4' X4
LANDMINE, RIG MOUNT X4	TARGET + DPU ADAPTER X4
NEUTRAL GRIP PULLUP X1	VERTICAL DUMBBELL RACK X2
PLATE STORAGE, 4' X4	WIDE SHELF, 4' X4
ROCK GRIP PULLUP X1	WIDE SHELF, 6' X3
ROPE ANCHOR, RIG MOUNT X4	XTC CROSSMEMBER, 6' X2
STORAGE BIN, 6' X2	

XTC COMPACT RIGS



XTC 2X4 COMPACT
9-XTC-204C-60THD

RECOMMENDED FLOOR SPACE	14' X 12' (4.5M X 4M)
INCLUDES:	
BALL SHELF, 4' X1	
BAR STORAGE X1	
PLATE STORAGE, 4' X1	
SQUAT STATION X1	
WIDE SHELF, 4' X1	



XTC 4X4 COMPACT
9-XTC-404C-60THD

RECOMMENDED FLOOR SPACE	14' X 14' (4.5M X 4.5M)
INCLUDES:	
BALL SHELF, 4' X1	
BAR STORAGE X1	
PLATE STORAGE, 4' X1	
SQUAT STATION X1	
WIDE SHELF, 4' X2	



XTC 2X8 COMPACT
9-XTC-208C-60THD

RECOMMENDED FLOOR SPACE	18' X 12' (5.5M X 4M)
INCLUDES:	
TRIANGLE PULL UP BAR X1	
DIP BAR X1	
WIDE SHELF, 4' X6	

COLOR CUSTOMIZATION

We know what it takes to build an authentic, meaningful brand experience. Our customization program is the perfect way to leverage your personal brand and make a strong first impression. Get Throwdown XTC rigs in a variety of custom color options.



BLACK -60



SILVER - 29



KARMINROT -30



ULTRAMARINE BLUE -73



GALVANIZED -01

DUAL POST ATTACHMENTS



**DUAL POST
MOUNT LOCATIONS**



FLYING PULLUP BAR, 4'
SKU: 51-00246-60-KT
MOUNT: DUAL POST

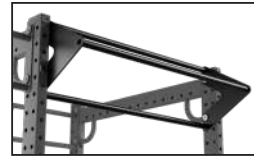

TRIANGLE PULLUP BAR, 4'
SKU: 51-00252-60-KT
MOUNT: DUAL POST

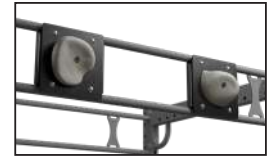

ROCK GRIP PULLUP
SKU: 71-00229-60-KT
MOUNT: DOUBLE PULLUP BAR

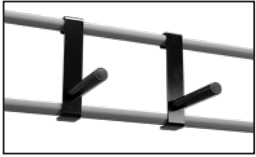

NEUTRAL GRIP PULLUP
SKU: 71-00268-60-KT
MOUNT: DOUBLE PULLUP BAR



SQUAT STATION
SKU: 73-00120-60-KT
MOUNT: DUAL POST

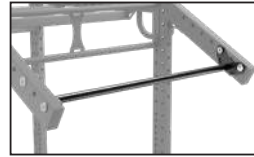

MEGA GRIP PULLUP BAR, 4'
SKU: 51-00293-60-KT
MOUNT: MUSCLEUP/POST

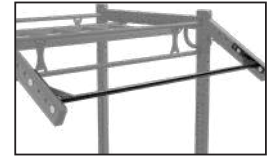

MEGA GRIP PULLUP BAR, 6'
SKU: 51-00314-60-KT
MOUNT: MUSCLEUP/POST



TARGET + DPU ADAPTER
SKU: 73-00121-29THD-KT
MOUNT: DOUBLE PULLUP BAR



XTC CROSSMEMBER, 6'
SKU: 52-00114-60-KT
MOUNT: DUAL POST



XTC CROSSMEMBER, 4'
SKU: 52-00113-60-KT
MOUNT: DUAL POST



WIDE SHELF, 4'
SKU: 52-00124-60-KT
MOUNT: DUAL POST



WIDE SHELF, 6'
SKU: 52-00125-60-KT
MOUNT: DUAL POST



BALL SHELF, 4'
SKU: 71-00271-60-KT
MOUNT: DUAL POST



KETTLEBELL SHELF, 4'
SKU: 73-00122-60-KT
MOUNT: DUAL POST

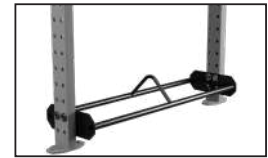

PLATE STORAGE, 4'
SKU: 71-00363-60-KT
MOUNT: DUAL POST



STORAGE BIN, 4'
SKU: 71-00402-60-KT
MOUNT: DUAL POST



STORAGE BIN, 6'
SKU: 52-00127-60-KT
MOUNT: DUAL POST



STABILITY BALL SHELF, 6'
SKU: 52-00156-60-KT
MOUNT: DUAL POST



PLYO SHELF, 6'
SKU: 73-00128-60-KT
MOUNT: DUAL POST

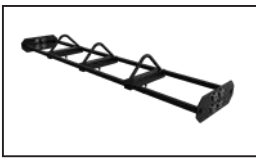
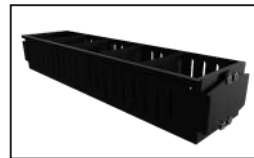

PLATE STORAGE, 6'
SKU: 73-00242-60-KT
MOUNT: DUAL POST



LOCKING DRAWER, 4'
SKU: 73-00268-60-KT
MOUNT: DUAL POST



LOCKING DRAWER, 6'
SKU: 73-00269-60-KT
MOUNT: DUAL POST



DRAWER TOPPER SHELF, 4'
SKU: 73-00280-60-KT
MOUNT: DUAL POST



DRAWER TOPPER SHELF, 6'
SKU: 73-00266-60-KT
MOUNT: DUAL POST



LOCKABLE BIN, 4'
SKU: 73-00282-60-KT
MOUNT: DUAL POST



LOCKABLE BIN, 6'
SKU: 73-00283-60-KT
MOUNT: DUAL POST

SINGLE POST ATTACHMENTS



**SINGLE POST
MOUNT LOCATIONS**



UNIVERSAL CLIP ATTACHMENT
SKU: 72-00108-60-KT
MOUNT: POST



STEP-UP
SKU: 71-00100-60-KT
MOUNT: POST



DIP BAR
SKU: 71-00101-60-KT
MOUNT: POST



LANDMINE, RIG MOUNT
SKU: 71-00227-60-KT
MOUNT: POST



BAR STORAGE
SKU: 71-00267-60-KT
MOUNT: POST



ROPE HANGER
SKU: 71-00360-60-KT
MOUNT: POST



VERTICAL DUMBBELL RACK
SKU: 71-00367-60-KT
MOUNT: POST



ROPE ANCHOR, RIG MOUNT
SKU: 71-00308-60-KT
MOUNT: POST



STORAGE PEG
SKU: 71-00357-60-KT
MOUNT: POST



CROSSMEMBER EXTENSION
SKU: 52-00144-60-KT
MOUNT: POST



MUSCLE UP ATTACHMENT
SKU: 52-00122-60-KT
MOUNT: DUAL POST



TARGET
SKU: 72-00133-29THD-KT
MOUNT: POST

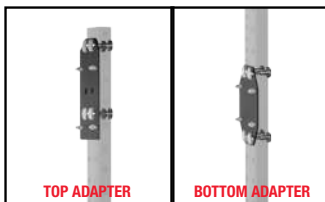

ROPE TRAINING ADAPTER KIT
SKU: 72-00109-60
MOUNT: POST



HEX BARBELL STORAGE KIT
SKU: 73-00239-60-KT
MOUNT: POST

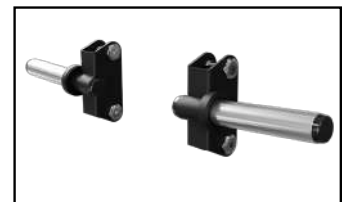

XTC WEIGHT HORN (LEFT, RIGHT)
SKU: 72-00142-XX-KT (LEFT)
72-00143-XX-KT (RIGHT)
MOUNT: POST

CROSSMEMBER ATTACHMENTS



**CROSSMEMBER
MOUNT LOCATIONS**



TARGET
SKU: 72-00133-29THD-KT
MOUNT: CROSSMEMBER

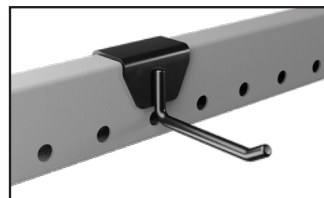

STORAGE PIN
SKU: 52-00139-60-KT
MOUNT: CROSSMEMBER



BAG HANGER
SKU: 71-00323-60-KT
MOUNT: CROSSMEMBER



THROWDOWN XTR™ STORAGE

Throwdown XTR Storage is built to be both functional and durable. Simple intricate designs keep the area around the training center clutter free and safe for all members. Each piece provides a specific storage solution for all of your functional training accessories.



XTR STANDARD STORAGE
9-XTR-6061-60



XTR BALL STORAGE
9-XTR-6062-60



XTR SUSPENSION STORAGE
9-XTR-6063-60



STABILITY BALL SHELF, 6'



WIDE SHELF, 6'



XTC CROSSMEMBER, 6'



STORAGE BIN, 6'

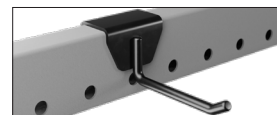

STORAGE PIN

COLOR CUSTOMIZATION

We know what it takes to build an authentic, meaningful brand experience. Our customization program is the perfect way to leverage your personal brand and make a strong first impression. Get Throwdown XTR storage in a variety of custom color options.



BLACK -60

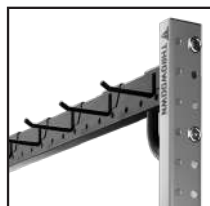

SILVER - 29



KARMINROT -30



ULTRAMARINE BLUE -73



GALVANIZED -01



Shown with optional Knux FXD Bench Set (Sku: TD-KNX-FXD-SET) which includes a set of 1lb, 2lb and 3lb Knux plus the Knux Holder

THROWDOWN FXD BENCH

The FXD Bench is a multi-functional bench with integrated storage. The bench was designed for efficient use with a live or virtual on-screen instructor. It allows most exercises to be accomplished while facing the instructor. The layout of the bench and modular attachment points facilitate quick transitions between exercises.

LENGTH	44.1 IN (112 CM)
WIDTH	16.5 IN (42 CM)
HEIGHT	16.9 IN (42.9 CM)
INTERNAL STORAGE DIMENSIONS (LxWxD)	5.25 x 23 x 11.5 IN (13.3 x 58.4 x 29.2 CM)
BENCH WEIGHT	138 LB (62.8 KG)
ACCESSORY WEIGHT	164 LB (74.5 KG)
OVERALL WEIGHT	302 LB (137.2 KG)
SHIPPING WEIGHT	350 LB (159 KG)
STANDARD FRAME COLOR OPTIONS	Black
STANDARD UPHOLSTERY COLOR OPTIONS	Black
CONSTRUCTION	Steel Frame, Molded Foam Cushion

PUSH POSITION



PULL POSITION



LB ACCESSORY KIT:

- (2) 5 LB Dumbbells, (2) 10 LB Dumbbells, (2) 15 LB Dumbbells
- (2) 20 LB Dumbbells, (1) 15 LB Kettlebell,
- (1) 30 LB Kettlebell, (1) 15 LB Slam Ball,
- (2) Level 1 Sleeved Resistance Tubes
- (2) Level 2 Sleeved Resistance Tubes,
- (2) Level 3 Sleeved Resistance Tubes,
- (2) Resistance Tube Handle Attachments,
- (2) Resistance Tube Ankle Attachments

KG ACCESSORY KIT:

- (2) 4 KG Dumbbells, (2) 6 KG Dumbbells, (2) 8 KG Dumbbells
- (2) 10 KG Dumbbells, (1) 8 KG Kettlebell,
- (1) 14 KG Kettlebell, (1) 8 KG Slam Ball,
- (2) Level 1 Sleeved Resistance Tubes
- (2) Level 2 Sleeved Resistance Tubes,
- (2) Level 3 Sleeved Resistance Tubes,
- (2) Resistance Tube Handle Attachments,
- (2) Resistance Tube Ankle Attachments

IMPACT SPORTS





SINGLE STATION TRAINING TREE



Throwdown's SSTT is a space efficient solution to offer impact fitness in any facility. This floor mounted bag rack can be used as a single unit in an open gym layout or as a series in a row to create the perfect group exercise experience. The Throwdown SSTT bag racks blend the best of impact sports and functional training that helps members meet their goals.

FREESTANDING BAG RACK



Designed for personal and small group training with an impact fitness focus, Throwdown FBR blend the best of impact sports and functional training and helps members meet their goals. Our innovative FBR system is engineered to expand with your growing business needs and provides ample spacing between bags to accommodate multiple members at a time.

ALPHA BAG RACK



Designed for a class-focused environment with the goal to increase speed, endurance, and explosiveness in impact fitness specifically, the Throwdown ABR blend the best of impact sports and functional training that helps members meet their goals.



*OPTIONAL LAYOUT EXAMPLE

THROWDOWN SSTT

Throwdown's Single Station Training Tree is a space efficient solution to offer impact fitness in any facility. This floor mounted bag rack can be used as a single unit in an open gym layout or as a series in a row to create the perfect group exercise experience. The Throwdown SSTT bag racks blend the best of impact sports and functional training that helps members meet their goals.



SSTS 9-SSTS-60

LENGTH	46.2" (117.3 CM)
WIDTH	12" (20.5 CM)
HEIGHT	96.2" (244.4 CM)
RECOMMENDED FLOOR SPACE	4' x 7' (122 CM x 213 CM)
CONSTRUCTION	7-gauge steel, 4" x 4" (10 CM x 10 CM) tubing
FINISH	Electrostatic Powder Coating
SHIPPING WEIGHT	130 LB (59 KG)
SHIPPING DIMENSIONS	96.5" x 42.25" x 12" (245 CM x 107 CM x 30.5 CM)

OPTIONAL ATTACHMENTS



MEGA GRIP PULL UP BAR, 4'
SKU: 51-00293-60-KT



BALLET BAR SET, 4'
SKU: 73-00187-60



BALLET BAR ADD-ON SET, 4'
SKU: 73-00188-60

COLOR CUSTOMIZATION

We know what it takes to build an authentic, meaningful brand experience. Our customization program is the perfect way to leverage your personal brand and make a strong first impression. Get Throwdown Single Station Training Tree in a variety of custom color options.



BLACK -60



SILVER - 29



KARMINROT -30



ULTRAMARINE BLUE -73





*ACCESSORIES NOT INCLUDED

THROWDOWN FBR™

Designed for personal and small group training with an impact fitness focus, Throwdown Freestanding Bag Racks blend the best of impact sports and functional training and helps members meet their goals. Our innovative FBR system is engineered to expand with your growing business needs and provides ample spacing between bags to accommodate multiple members at a time.



FBR 6x12 9-FBR-0612-60

LENGTH	153.95" (391 CM)
WIDTH	81.95" (208 CM)
HEIGHT	102" (259 CM)
RECOMMENDED FLOOR SPACE	11' x 17' (3.35 M X 5.18 M)
BAG SPACING	4.5' (137 CM)
CONSTRUCTION	7-gauge steel, 4"x4" (10cm x 10cm) tubing
FINISH	Electrostatic Powder coating



FBR 6X24 9-FBR-0624-60

LENGTH	297.9" (756.7 CM)
WIDTH	81.95" (208 CM)
HEIGHT	102" (259 CM)
RECOMMENDED FLOOR SPACE	11' x 29' (3.35 x 8.8 M)
BAG SPACING	4.5' (137 CM)
CONSTRUCTION	7-gauge steel, 4"x4" (10cm x 10cm) tubing
FINISH	Electrostatic Powder coating



FBR 12X12 9-FBR-1212-60

LENGTH	153.95" (391CM)
WIDTH	153.95" (391CM)
HEIGHT	102" (259 CM)
RECOMMENDED FLOOR SPACE	17' X 17' (5.2 X 5.2 M)
BAG SPACING	4.5' (137 CM)
CONSTRUCTION	7-gauge steel, 4"x4" (10cm x 10cm) tubing
FINISH	Electrostatic Powder coating



FBR 12X24 9-FBR-1224-60

LENGTH	297.9" (756.7CM)
WIDTH	153.95" (391CM)
HEIGHT	102" (259CM)
RECOMMENDED FLOOR SPACE	17' X 29' (5.2 X 8.8 M)
BAG SPACING	4.5' (137 CM)
CONSTRUCTION	7-gauge steel, 4"x4" (10cm x 10cm) tubing
FINISH	Electrostatic Powder coating



FBR 24X24 9-FBR-2424-60

LENGTH	297.9" (756.7 CM)
WIDTH	297.9" (756.7 CM)
HEIGHT	102" (259 CM)
RECOMMENDED FLOOR SPACE	29' X 29' (8.8 X 8.8 M)
BAG SPACING	4.5' (137 CM)
CONSTRUCTION	7-gauge steel, 4"x4" (10cm x 10cm) tubing
FINISH	Electrostatic Powder coating

OPTIONAL ATTACHMENTS

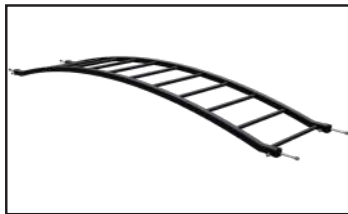

MONKEY BARS

SKU: 71-00143-60
MOUNT: CROSSMEMBER



PULL UP

SKU: 71-00377-60
MOUNT: CROSSMEMBER



ADD-ON BEAM

SKU: 73-00130-60
MOUNT: CROSSMEMBER

COLOR CUSTOMIZATION

We know what it takes to build an authentic, meaningful brand experience. Our customization program is the perfect way to leverage your personal brand and make a strong first impression. Get Throwdown Freestanding Bag Racks in a variety of custom color options.



BLACK -60



SILVER - 29



KARMINROT -30



ULTRAMARINE BLUE -73



*ACCESSORIES NOT INCLUDED

THROWDOWN ABR™

Designed for a class-focused environment with the goal to increase speed, endurance, and explosiveness in impact fitness specifically, the Throwdown Alpha Bag Racks blend the best of impact sports and functional training that helps members meet their goals.



9X18 ABR 8-BAG 9-ABR-1808-60

LENGTH	226" (574 CM)
WIDTH	118" (300 CM)
HEIGHT	107" (271 CM)
RECOMMENDED FLOOR SPACE	19' x 28' (5.8 x 8.5 M)
BAG SPACING	4.5' (137 CM)
BAG POSITIONS	8
CONSTRUCTION	7-gauge steel, 4"x 4" (10cm x 10cm) tubing
FINISH	Electrostatic Powder Coating



9X18 ABR 12-BAG 9-ABR-1812-60

LENGTH	267" (680 CM)
WIDTH	118" (300 CM)
HEIGHT	107" (271 CM)
RECOMMENDED FLOOR SPACE	19' x 32' (5.8 x 9.8 M)
BAG SPACING	4.5' (137 CM)
BAG POSITIONS	12
CONSTRUCTION	7-gauge steel, 4"x 4" (10cm x 10cm) tubing
FINISH	Electrostatic Powder Coating



9X18 ABR 16-BAG 9-ABR-1816-60

LENGTH	267" (680 CM)
WIDTH	152" (386 CM)
HEIGHT	107" (271 CM)
RECOMMENDED FLOOR SPACE	22' x 32' (6.7 x 9.8 M)
BAG SPACING	4.5' (137 CM)
BAG POSITIONS	16
CONSTRUCTION	7-gauge steel, 4"x 4" (10cm x 10cm) tubing
FINISH	Electrostatic Powder Coating



9X36 ABR 16-BAG 9-ABR-3616-60

LENGTH	441" (1122 CM)
WIDTH	118" (300 CM)
HEIGHT	107" (271 CM)
RECOMMENDED FLOOR SPACE	19' x 46' (5.8 x 14 M)
BAG SPACING	4.5' (137 CM)
BAG POSITIONS	16
CONSTRUCTION	7-gauge steel, 4"x 4" (10cm x 10cm) tubing
FINISH	Electrostatic Powder Coating



9X36 ABR 20-BAG 9-ABR-3620-60

LENGTH	484" (1228 CM)
WIDTH	118" (300 CM)
HEIGHT	107" (271 CM)
RECOMMENDED FLOOR SPACE	19' x 50' (5.8 x 15.2 M)
BAG SPACING	4.5' (137 CM)
BAG POSITIONS	20
CONSTRUCTION	7-gauge steel, 4"x 4" (10cm x 10cm) tubing
FINISH	Electrostatic Powder Coating



9X18 ABR 20-BAG 9-ABR-1820-60

LENGTH	267" (680 CM)
WIDTH	152" (386 CM)
HEIGHT	107" (271 CM)
RECOMMENDED FLOOR SPACE	22' x 32' (6.7 x 9.8 M)
BAG SPACING	4.5' (137 CM)
BAG POSITIONS	20
CONSTRUCTION	7-gauge steel, 4"x 4" (10cm x 10cm) tubing
FINISH	Electrostatic Powder Coating



9X36 ABR 24-BAG 9-ABR-3624-60

LENGTH	484" (1228 CM)
WIDTH	152" (386 CM)
HEIGHT	107" (271 CM)
RECOMMENDED FLOOR SPACE	22' x 50' (6.7 x 15.2 M)
BAG SPACING	4.5' (137 CM)
BAG POSITIONS	24
CONSTRUCTION	7-gauge steel, 4"x 4" (10cm x 10cm) tubing
FINISH	Electrostatic Powder Coating



9X36 ABR 28-BAG 9-ABR-3628-60

LENGTH	484" (1228 CM)
WIDTH	152" (386 CM)
HEIGHT	107" (271 CM)
RECOMMENDED FLOOR SPACE	22' x 50' (6.7 x 15.2 M)
BAG SPACING	4.5' (137 CM)
BAG POSITIONS	28
CONSTRUCTION	7-gauge steel, 4"x 4" (10cm x 10cm) tubing
FINISH	Electrostatic Powder Coating



9X36 ABR 36-BAG 9-ABR-3636-60

LENGTH	484" (1228 CM)
WIDTH	152" (386 CM)
HEIGHT	107" (271 CM)
RECOMMENDED FLOOR SPACE	22' x 50' (6.7 x 15.2 M)
BAG SPACING	4.5' (137 CM)
BAG POSITIONS	36
CONSTRUCTION	7-gauge steel, 4"x 4" (10cm x 10cm) tubing
FINISH	Electrostatic Powder Coating

COLOR CUSTOMIZATION

We know what it takes to build an authentic, meaningful brand experience. Our customization program is the perfect way to leverage your personal brand and make a strong first impression. Get Throwdown Alpha Bag Racks in a variety of custom color options.



BLACK -60



SILVER - 29



KARMINROT -30



ULTRAMARINE BLUE -73

NEW





The GlideBoxx turns your punching bag into an active opponent by allowing the bag to react to your strikes and coming back at you forcing you to train footwork and angles in a realistic way. Great for Boxing, Muay Thai, MMA, and Kickboxing.

GLIDEBOXX 9-TD-GBX3-XX

WIDTH	74 IN (188 CM)
DEPTH	56 IN (142 CM)
HEIGHT	14 IN (37 CM)
FRAME CONSTRUCTION	HEAVY-GAUGE WELDED STEEL
COLOR SCHEME	MATTE BLACK
FINISH	ELECTROSTATIC POWDER COATING FOR LONG LASTING DURABILITY
MACHINE WEIGHT	153 LBS (69 KG)



HIIT ROPE TD-RPT01

LENGTH	22 IN (55.8 CM)
WIDTH	8.2 IN (20.7 CM)
HEIGHT	16 IN (40.6 CM)
RESISTANCE TECHNOLOGY	Magnetic Resistance with resistance control lever
RESISTANCE LEVELS	6 levels of resistance
ROPE	3 Strand Twist
MAX USER WEIGHT	350 LB (159 KG)
FRAME CONSTRUCTION	Heavy-gauge welded steel
COLOR SCHEME	Matte Black
FINISH	Electrostatic Powder Coating for long lasting durability
MACHINE WEIGHT	41.7 LB (18.9 KG)
SHIPPING DIMENSIONS	26.4 IN x 16.5 IN x 18.9 IN
SHIPPING WEIGHT	50.5 LB (22.9 KG)

HIIT SKI

The Throwdown HIIT SKI replicates the exhilarating motions of cross-country skiing within the confines of the gym. Its sleek design and user-friendly interface make it an enticing addition to any workout space. As one of the few fan-based resistance machines that train upper-body endurance, the HIIT SKI works harder against you the harder you work, taxing your arms, legs, core and cardio! Whether you're a seasoned athlete or just starting your fitness journey, the HIIT SKI's ability to provide a dynamic full-body workout is undeniably impressive.

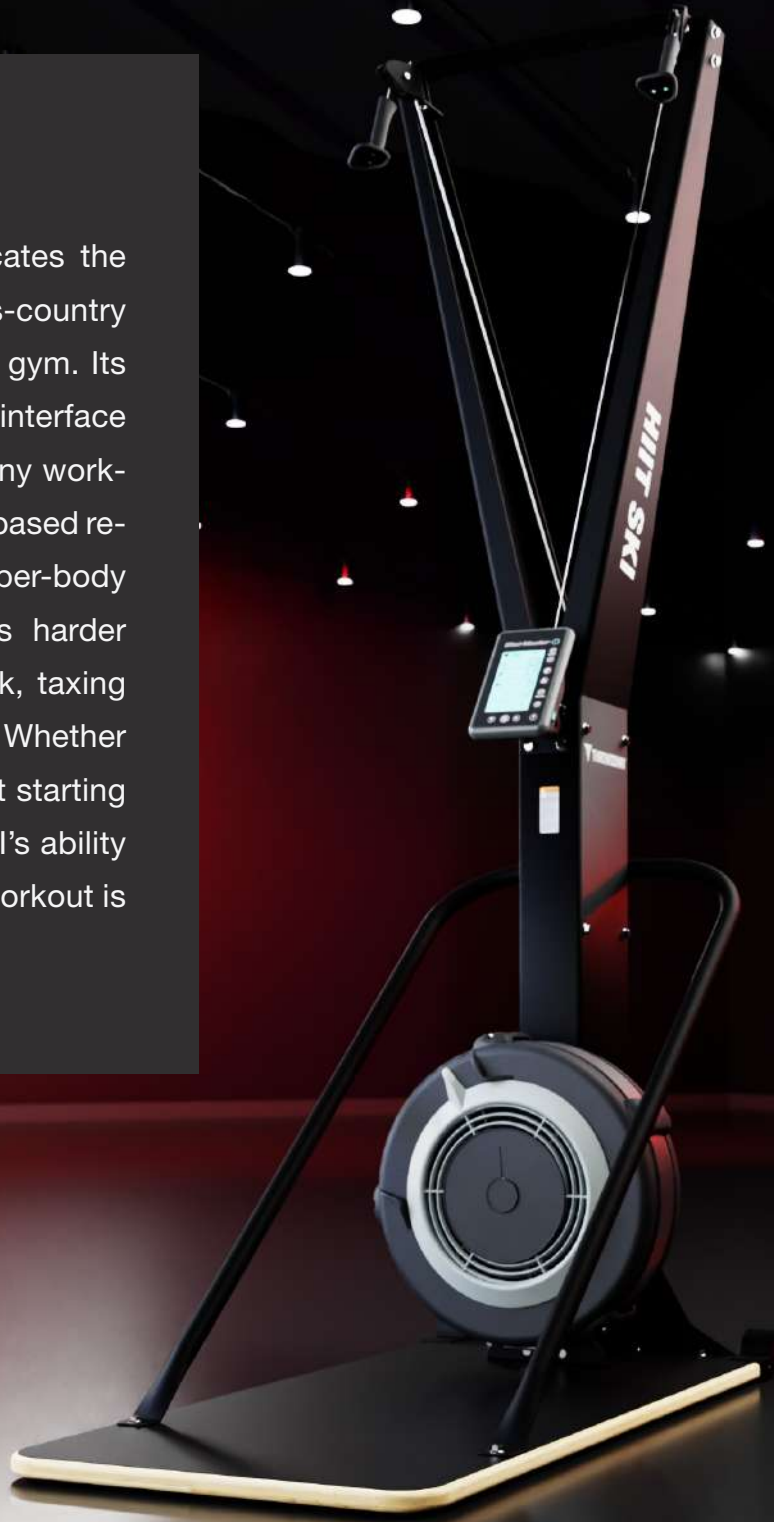

**N
E
W**



HIIT SKI 9-4710

HEIGHT	85 IN (216 CM)
WIDTH	20 IN (52 CM)
DEPTH	16 IN (40 CM)
DRIVE SYSTEM	HMPE CORD
RESISTANCE TECHNOLOGY	Isokinetic fan resistance offers unlimited workout options, while fan dampening system allows for increased or decreased workloads at a given stroke rate
CHAIN OR CORD	CORD
MAX USER WEIGHT	350 LBS (159 KG)
FRAME CONSTRUCTION	Heavy-gauge welded steel and aluminum construction
COLOR SCHEME	Matte Black
FINISH	Electrostatic Powder Coating for long lasting durability
MACHINE WEIGHT	52 LBS (23 KG)



HIIT SKI W PLATFORM 9-4710 AND 716-0176

HEIGHT	85 IN (216 CM)
WIDTH	23 IN (59 CM)
DEPTH	50 IN (127 CM)
FRAME CONSTRUCTION	Heavy-gauge welded steel and aluminum construction
COLOR SCHEME	Matte Black
MACHINE WEIGHT	95 LBS (43 KG)



FIT ACCESSORIES



ACCESSORIES

With over 25 product offerings the Throwdown FIT Accessories product line offers the equipment you need in a single buying experience. Including foam rollers, jump and speed ropes, plyo boxes, resistance bands, battle ropes and anchors, FIT dummies and more.

[SCAN THE QR OR VISIT COREHANDF.COM/THROWDOWN TO VIEW OUR ENTIRE PRODUCT LINE](https://www.corehandf.com/throwdown)



BALLS

From stability balls to slam balls, we have the products needed to round out your XTC Rig in whatever configuration you're creating.

[SCAN THE QR OR VISIT COREHANDF.COM/THROWDOWN TO VIEW OUR ENTIRE PRODUCT LINE](https://www.corehandf.com/throwdown)



BAGS

Throwdown Bags are constructed of T-Flex Tarpoline shells with industrial fiber fill and feature nylon, adjustable, webbed hanging straps. Hardware kits are included with each bag and are made from custom premium wear resistant steel. No matter your set up, we have the bag for you.

[SCAN THE QR OR VISIT COREHANDF.COM/THROWDOWN TO VIEW OUR ENTIRE PRODUCT LINE](https://www.corehandf.com/throwdown)

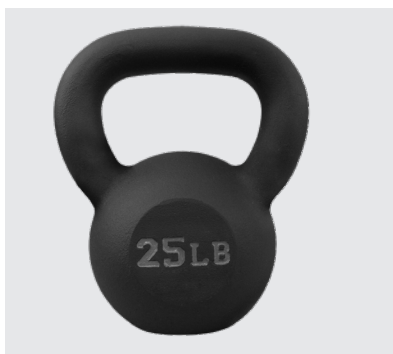

WEIGHTS, PLATES, BARS WITH RACKS

Throwdown FIT Accessories offers an exceptional value free weight solution to your functional training space. Rounding out our FIT offering is the Bumper Plate Storage Cart. This durable pieces offer efficient and portable design that will save space in your facility.

[SCAN THE QR OR VISIT COREHANDF.COM/THROWDOWN TO VIEW OUR ENTIRE PRODUCT LINE](https://www.corehandf.com/throwdown)



KEVLAR

TKTK

[SCAN THE QR OR VISIT COREHANDF.COM/THROWDOWN TO VIEW OUR ENTIRE PRODUCT LINE](https://www.corehandf.com/throwdown)



FOAM ROLLERS

- High density foam
- Therapeutic benefits
- Roller maintains its form and feel
- Two sizes available: 18" and 36" long
 - Black
 - Sold individually
- SKU: 18" (TD-FMR-18)
- SKU: 36" (TD-FMR-36)



EXERCISE MATS

- Closed cell foam is light and resilient
- Includes eyelets for hanging storage
- Provides a base for comfortable floor exercises and stretching
 - Black
 - Sold individually
- SKU: 21" x 48" (TD-EXM-48)
- SKU: 21" x 66" (TD-EXM-66)



AGILITY CONES

- Stackable & Lightweight
- Improve speed, agility, balance and coordination
 - 5" x 1.25"
 - Light Grey
- Sold in sets of 10
- SKU: TD-AC

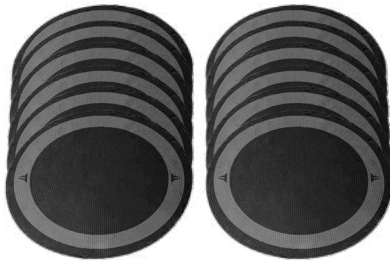

AGILITY DOTS

- Soft, flexible, plastic non-slide markers
 - 7" diameter
 - Black/Grey
- Sold in sets of 12
- SKU: TD-DOT-SET



PREMIUM ABDOMINAL WHEELS

- Simple, yet effective training tool that targets the abs, shoulders and back
- Smooth, 8" rubber wheel with ball bearings
 - Padded handles
 - 8" x 8" x 11"
 - Grey/Black
 - Sold individually
- SKU: TD-ABW

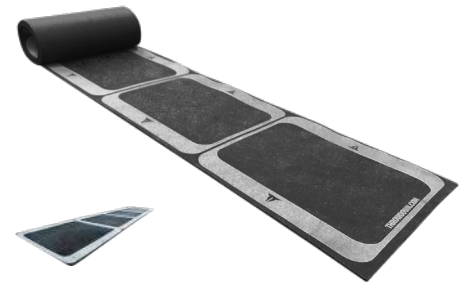

AGILITY LADDERS

- Premium black recycled rubber
- Improve speed, agility, balance and coordination
 - 16' x 15"
 - Black/Grey
- Sold individually
- SKU: TD-AGL



FLOOR SLIDERS

- Efficient design invites multiple bodyweight exercises with maximum range of motion
 - For carpet and turf
 - Black
- Sold in pairs
- SKU: TD-FLS



JUMP ROPES

- Rubber rope for speed
- Ergonomically designed handle with internal ball-bearing eliminates rope curling
 - Three, color coded lengths
 - Sold individually
- SKU: 8' Yellow - (TD-JR-8)
- SKU: 9' Neon Green - (TD-JR-9)
- SKU: 10' Blue - (TD-JR-10)



SPEED ROPES

- Adjustable, black coated wire rope
- Polymer handles with precision ball bearings
- Sold individually
- SKU: TD-SR



DYNAMIC RESISTANCE BANDS

- Made of latex, each band varies in color, width, thickness and tension for specialized training
- Sold individually
- SKU: Level 1 - 1/2" Red (TD-RB-L1)
- SKU: Level 2 - 3/4" Black (TD-RB-L2)
- SKU: Level 3 - 1 1/4" Purple (TD-RB-L3)
- SKU: Level 4 - 1 3/4" Green (TD-RB-L4)
- SKU: Level 5 - 2 1/2" Blue (TD-RB-L5)
- SKU: Level 6 - 3 1/4" Orange (TD-RB-L6)



MINI RESISTANCE BANDS

- Each band varies in color, thickness & tension for specialized training.
- 2" wide x 12" diameter, made of latex
- Sold in sets of 5
- SKU: Assorted Set - One Each (TD-MRB-SET)
- SKU: Level 1 - Yellow (TD-MRB-L1-SET)
- SKU: Level 2 - Green (TD-MRB-L2-SET)
- SKU: Level 3 - Blue (TD-MRB-L3-SET)
- SKU: Level 4 - Black (TD-MRB-L4-SET)
- SKU: Level 5 - Red (TD-MRB-L5-SET)



SLEEVED RESISTANCE TUBING

- Padded, textured handles for a firm, comfortable grip
- Five tensions
- Grey/Color coded
- Sold individually
- SKU: Level 1 Orange (TD-ST-L1)
- SKU: Level 2 Black (TD-ST-L2)
- SKU: Level 3 Purple (TD-ST-L3)
- SKU: Level 4 Green (TD-ST-L4)
- SKU: Level 5 Blue (TD-ST-L5)



3-N-1 POWER PLYOS

- Sturdy foam core provides the perfect jump platform
- Durable vinyl cover
- Provides 20", 24" and 30" jump heights
- Black/Color coded height designation
- Sold individually
- SKU: TD-PB-3N1-C



POWER PLYO SETS

- Firm foam boxes are stackable, providing seven jump heights (6", 12", 18", 24", 30", 36" and 42".)
- Three individual boxes measuring 6", 12" and 24"
- Durable vinyl cover with a wide 30"x36" base
- Boxes attach with Velcro connections
- Black/Color coded height designation
- Sold in sets
- SKU: TD-PB-SET-C

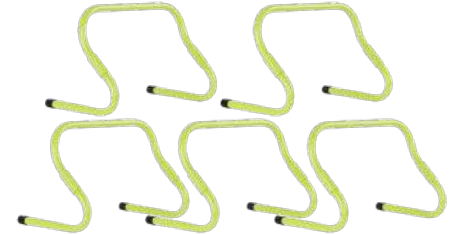

ADJUSTABLE SPEED HURDLES

- Made of durable PVC
- 2 height adjustments, 7" & 12"
- Bright green
- Sold in sets of 5
- SKU: TD-ASH



HIIT INTERVAL WHITE BOARD MAGNETS

- White dry erase magnets provide a simple way to set up your station workouts
- Mountable to all steel surfaces
- 4" x 6"
- White
- Sold in sets of 20
- SKU: 91-00202



PORTABLE LEGEND LANDMINES

- Steel construction
- Conveniently secured using two bumper plates
- Compatible with most barbells
- Black
- Sold individually
- SKU: TD-PLM



STATIONARY LEGEND LANDMINES

- Sturdy steel construction to build core strength
- Bolts to any floor for worry-free stability
- Compatible with most barbells
- Black
- Sold individually
- SKU: 72-00114-60



FACILITY SERIES GROUND-N-POUND DUMMIES

- Industrial grade construction with fiber fill
 - Webbing overlays reinforced structural seams
 - Used for a variety of striking & grappling drills
 - 5.6" tall / 90 LB.
 - Black
 - Sold individually
- SKU: TD-GDM-90



FIT DUMMIES

- Industrial grade construction with fiber fill
 - Practice and perfect a variety of lifts, carries, throws and ground techniques
 - Angled design and filling mimics a real body
 - Two sizes
 - Black
 - Sold individually
- SKU: 60 LB (TD-DMY-60-TD)
SKU: 75 LB (TD-DMY-75-TD)

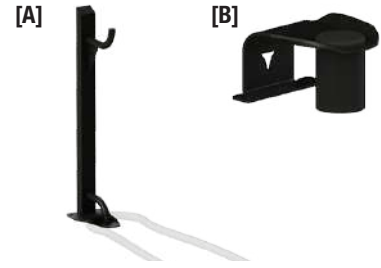

ROPE ANCHORS

- Instrumental partner component for every battle rope
 - Steel Construction
 - Mounts to floor
 - Black
 - Sold individually
- SKU: [A] Standing Rope Anchor w/ Storage (52-00118-60)
SKU: [B] Floor Mount Rope Anchor (TD-FRPA)



BATTLE ROPES

- Heavy-duty, woven rope
 - Secured hand grips on both ends
 - Available in 20' & 30' Length
 - Black
 - Sold individually
- SKU: 1.5" x 20' (TD-BTR-20-1.5)
SKU: 1.5" x 30' (TD-BTR-1.5)
SKU: 2" x 30' (TD-BTR-2)



SUPER SLEDS

- Sturdy, steel construction
 - Multi-directional design for partner training
 - Multiple grip options
 - Collapsible
 - Silver/Black
 - Sold individually
- SKU: 71-00432



SLED / CLIMBING ROPES

- Heavy-duty, woven rope
 - Secured hand grips on both ends
 - 15' & 20' full length ropes
 - Available in 1.5" diameter
 - Black
 - Sold individually
- SKU: 1.5" x 15' (TD-CLR-1.5)
SKU: 1.5" x 20' (TD-SLR-1.5)



OLYMPIC RINGS

- Specifically designed for suspension training
 - Complete with nylon straps
 - Great for both beginner to expert users
 - Wood ring offers a firm, comfortable grip
 - Sold in pairs
- SKU: TD-OR



SUSPENSION TRAINERS

- Versatile training kit uses gravity to build muscle, balance and endurance
 - Includes nylon webbed straps, door anchor and carrying bag
 - Black/Grey
 - Sold individually
- SKU: TD-SST



STABILITY BALL

- Made of anti-burst vinyl
 - Develop abdominal strength and balance
 - Ships deflated (pump not included)
 - Two sizes: 55cm and 65cm
 - Grey
 - Sold individually
- SKU: 55 cm (TD-STB-55)
SKU: 65 cm (TD-STB-65)



BALANCE TRAINER

- Non-skid, rubber platform
- Durable, ribbed half-ball fills with air, facilitating multiple training routines
 - 25.5" Diameter
 - Air pump included
 - Grey/Black
- Sold individually
- SKU: TD-BTP



MEDICINE BALLS

- Functional 14" diameter
- Reinforced shell and soft fill material provide a balanced shape
 - Available in pounds
 - Black/Grey
- Sold individually
- SKUS:

5 LB (TD-MB-5)	15 LB (TD-MB-15)
8 LB (TD-MB-8)	20 LB (TD-MB-20)
10 LB (TD-MB-10)	25 LB (TD-MB-25)



SLAM BALLS (LB)

- Rubberized shell provides a non-slip grip
 - 9" diameter and 11" diameter
- Available in both pounds & kilograms
 - Black/Grey
- Sold individually
- SKUS:

5 LB(TD-SLB-5)	30 LB (TD-SLB-30)
10 LB(TD-SLB-10)	35 LB (TD-SLB-35)
15 LB(TD-SLB-15)	40 LB (TD-SLB-40)
20 LB(TD-SLB-20)	45 LB (TD-SLB-45)
25 LB (TD-SLB-25)	50 LB (TD-SLB-50)



SLAM BALLS (KG)

- Sturdy foam core provides the perfect jump - Rubberized shell provides a non-slip grip
- 4 - 12 KGs. (9" diameter), 15 KG. (11" diameter)
 - Available in both pounds & kilograms
 - Black/White
- Sold individually
- SKUS:

+4 KG - (TD-SLB-4KG)	+ 10 KG - (TD-SLB-10KG)
+ 5 KG - (TD-SLB-5KG)	+ 12 KG - (TD-SLB-12KG)
+ 8 KG - (TD-SLB-8KG)	+ 15 KG - (TD-SLB-15KG)



4' HEAVY BAGS

- T-Flex Tarpoline shell with industrial fiber fill
- Nylon, adjustable, webbed hanging straps
- Heavy bag hardware kit is included with each bag, made from custom premium wear resistant steel.
- 16" x 48" / 100 LB.
 - Black
- Sold individually
- SKU: TD-HB-4



6' HEAVY BAGS

- T-Flex Tarpoline shell with industrial fiber fill
- Nylon, adjustable, webbed hanging straps
- Heavy bag hardware kit is included with each bag, made from custom premium wear resistant steel.
- 14" x 72" / 120 LB. Filled
 - Black
- Sold individually
- SKU: TD-HB-6



TEARDROP BAGS

- T-Flex Tarpoline shell with industrial fiber fill
- Nylon, adjustable, webbed hanging straps
- Heavy bag hardware kit included, made from custom premium wear resistant steel.
- 14" x 35" / 75 LB.
 - Black
- Sold individually
- SKU: TD-TDB



UPPERCUT BAGS

- T-Flex Tarpoline shell with industrial fiber fill
- Nylon, adjustable, webbed hanging straps
- Heavy bag hardware kit included, made from custom premium wear resistant steel.
- 30" x 16" / 70 LB.
 - Black
- Sold individually
- SKU: TD-UB

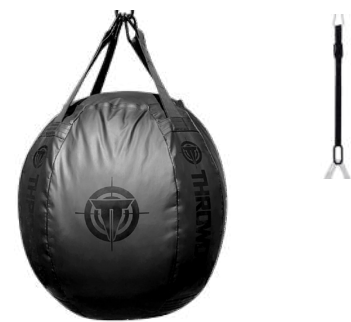

WRECKING BALL BAGS

- T-Flex Tarpoline shell with industrial fiber fill
- Nylon, adjustable, webbed hanging straps
- Heavy bag hardware kit included, made from custom premium wear resistant steel.
- Tactical strap included
 - 22" x 24" / 100 LB.
 - Black
- Sold individually
- SKU: TD-WB



FIT BUMPER PLATES (LB)

- Made of rubber, minimizing gym noise
- Durable stainless-steel insert
 - Color coded
 - Sold individually
- SKU: 10 LB Green (TD-BP-10)
- SKU: 25 LB Yellow (TD-BP-25)
- SKU: 35 LB Blue (TD-BP-35)
- SKU: 45 LB Red (TD-BP-45)



FIT BUMPER PLATES (KG)

- Made of rubber, minimizing gym noise
- Durable stainless-steel insert
 - Black/White
 - Sold individually
- SKU: 5 KG (TD-BP-5KG)
- SKU: 10 KG (TD-BP-10KG)
- SKU: 15 KG (TD-BP-15KG)
- SKU: 20 KG (TD-BP-20KG)



FIT BUMPER PLATES (LB)

- Made of rubber, minimizing gym noise
- Durable stainless-steel insert
 - Available in pounds only
 - Color coded
 - Sold individually
- SKU: 10 LB Green (FIT-BMPPLT-10LB-GRN)
- SKU: 25 LB Yellow (FIT-BMPPLT-25LB-YLW)
- SKU: 35 LB Blue (FIT-BMPPLT-35LB-BLU)
- SKU: 45 LB Red (FIT-BMPPLT-45LB-RED)



OLYMPIC BARS

- 15 KG - 25 mm diameter
- 20KG - 28 mm diameter
- Standard Olympic Knurl marks
 - Two weights
- Black zinc bar w/ hard chrome bar ends
 - Sold individually
- SKU: 15KG (TD-OB-15KG)
- SKU: 20KG (TD-OB-20KG)



OLYMPIC BAR COLLARS

- Single motion locking mechanism
- Lightweight and easy to maneuver
 - Black
 - Sold in pairs
- SKU: FIT-OLYCOL-OS-BK



LIGHT NEO DUMBBELLS

- PVC-encased, minimizing noise
- Available in pounds
 - Black/Grey
 - Sold individually
- SKU: 1 LB (TD-LDB-1)
- SKU: 2 LB (TD-LDB-2)
- SKU: 3 LB (TD-LDB-3)



SUPER SAND BAGS

- Hook & loop closure prevents sand leakage
- Tough, nylon construction
 - Six sizes available
 - One internal bag included
 - Black
 - Sold individually
- SKU: 25-75 LB Unfilled (TD-SB-SM)
- SKU: 80-120 LB Unfilled (TD-SB-LG)

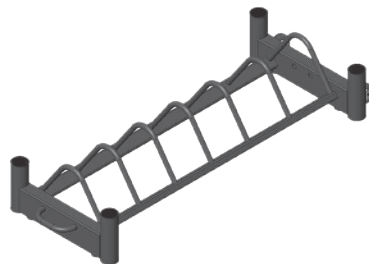

BUMPER PLATE STORAGE CART

- Sturdy, steel construction minimizes vibration and noise
- Stores Bumper Plates & Bars
 - Efficient, portable design
 - Silver
 - Sold individually
- SKU: TD-BPC



KNUX

- Front center weight designed to mimic the weight of boxing gloves
- Ergonomically molded to fit users' hand resulting in a comfortable and secure grip.
 - SKU: 1 LB (TD-KNX-1)
 - SKU: 2 LB (TD-KNX-2)
 - SKU: 3 LB (TD-KNX-3)
 - SKU: 5 LB (TD-KNX-5)
 - SKU: 8 LB (TD-KNX-8)



HIIT HEX DUMBBELLS (LB)

- Made of latex, each band varies in color, width,
- Rubber-encased heads minimize noise and floor damage
- Custom designed and manufactured chrome wear-resistant handles
 - Available in both pounds & kilograms
 - Black/Grey
 - Sold individually

SKUS:

5 LB (TD-HDB-5)	55 LB (TD-HDB-55)
8 LB (TD-HDB-8)	60 LB (TD-HDB-60)
10 LB (TD-HDB-10)	65 LB (TD-HDB-65)
15 LB (TD-HDB-15)	70 LB (TD-HDB-70)
20 LB (TD-HDB-20)	75 LB (TD-HDB-75)
25 LB (TD-HDB-25)	80 LB (TD-HDB-80)
30 LB (TD-HDB-30)	85 LB (TD-HDB-85)
35 LB (TD-HDB-35)	90 LB (TD-HDB-90)
40 LB (TD-HDB-40)	95 LB (TD-HDB-95)
45 LB (TD-HDB-45)	100 LB (TD-HDB-100)
50 LB (TD-HDB-50)	



HIIT HEX DUMBBELLS (KG)

- Rubber-encased heads minimize noise and floor damage
- Custom designed and manufactured chrome wear-resistant handles
 - Available in both pounds & kilograms
 - Black/White
 - Sold individually

SKUS:

2 KG (TD-HDB-2KG)	10 KG (TD-HDB-10KG)
3 KG (TD-HDB-3KG)	12.5 KG (TD-HDB-12.5KG)
4 KG (TD-HDB-4KG)	15 KG (TD-HDB-15KG)
5 KG (TD-HDB-5KG)	17.5 KG (TD-HDB-17.5KG)
6 KG (TD-HDB-6KG)	20 KG (TD-HDB-20KG)
7 KG (TD-HDB-7KG)	22.5 KG (TD-HDB-22.5KG)
8 KG (TD-HDB-8KG)	25 KG (TD-HDB-25KG)
9 KG (TD-HDB-9KG)	30 KG (TD-HDB-30KG)



FITNESS KETTLE BELLS

- Powder-coated, balanced, single-piece casting
 - Flat, wobble-free base
 - Available in pounds
 - Black/Grey
 - Sold individually

SKUS:

5 LB (TD-FKB-5)	35 LB (TD-FKB-35)
8 LB (TD-FKB-8)	40 LB (TD-FKB-40)
10 LB (TD-FKB-10)	45 LB (TD-FKB-45)
15 LB (TD-FKB-15)	50 LB (TD-FKB-50)
20 LB (TD-FKB-20)	60 LB (TD-FKB-60)
25 LB (TD-FKB-25)	80 LB (TD-FKB-80)
30 LB (TD-FKB-30)	100 LB (TD-FKB-100)



COMPETITION KETTLE BELLS

- Balanced, single-piece casting
 - Flat, wobble-free base
 - Available in kilograms
 - Sold individually

SKUS:

8 KG Pink (TD-CKB-8KG)	32 KG Red (TD-CKB-32KG)
12KG L.Blue (TD-CKB-12KG)	36 KG Gray (TD-CKB-36KG)
16 KG Yellow (TD-CKB-16KG)	40 KG White (TD-CKB-40KG)
20 KG Purple (TD-CKB-20KG)	44 KG D. Blue (TD-CKB-44KG)
24 KG Green (TD-CKB-24KG)	48 KG Gold (TD-CKB-48KG)
28 KG Orange (TD-CKB-28KG)	



KEVLAR PRODUCTS

NEW



KEPROTEC® KEVLAR® SAND DISC W/ FOAM HANDLES

Our Sand Disc with Foam Handles provide extra grip on the edges for added exercises, control, and grip strength. This highly durable sand disc keeps its shape due to its heavy-duty construction. Filled with steel sand, the shape enhances workouts due to the shift in the sand during use. Soft weight prevents damage to the user and to the floor.

SKU	DESCRIPTION	DIAMETER	WEIGHT	CARTON SIZE
TD-SD-KEV-5LB	KEVLAR SAND DISC	23 CM	5 LB	10 X 10 X 4 INCH
TD-SD-KEV-10LB	KEVLAR SAND DISC	29 CM	10 LB	13 X 13 X 4 INCH
TD-SD-KEV-15LB	KEVLAR SAND DISC	33.5 CM	15 LB	15 X 15 X 4 INCH
TD-SD-KEV-20LB	KEVLAR SAND DISC	38.5 CM	20 LB	15 X 15 X 4 INCH
TD-SD-KEV-25LB	KEVLAR SAND DISC	41.5 CM	25 LB	17 X 17 X 4 INCH
TD-SD-KEV-30LB	KEVLAR SAND DISC	44.5 CM	30 LB	17 X 17 X 4 INCH
TD-SD-KEV-35LB	KEVLAR SAND DISC	46 CM	35 LB	18 X 18 X 5 INCH
TD-SD-KEV-40LB	KEVLAR SAND DISC	48 CM	40 LB	18 X 18 X 5 INCH
TD-SD-KEV-45LB	KEVLAR SAND DISC	49.5 CM	45 LB	19 X 19 X 6 INCH
TD-SD-KEV-50LB	KEVLAR SAND DISC	50 CM	50 LB	19 X 19 X 6 INCH



TACTEC KEVLAR® INFINITY™ WORKOUT MAT

An ultra-dense, ultra-durable performance mat that has unmatched comfort and cushioning. Built with our proprietary TacTec™ Kevlar® on one side and high-density rubber on the other. This mat perfectly blends quality and performance for stretching, or general fitness. Mat measures 72"L x 24"W and 6mm thick.

SKU	DESCRIPTION	MAT SIZE	CARTON SIZE
TD-EXM-KEV-72	KEVLAR/RUBBER MAT	72 IN X 24 IN X 6 MM	25 X 6 X 6 INCH



KEPROTEC® KEVLAR® SANDBAG

This extremely durable sandbag will help you take your total body workouts to a new level. The Kevlar® fiber cover featuring 5 nylon handles with reinforced stitching allows for the most heavy of use. Special interior construction prevents weight from shifting around in bag and helps the bag maintain its shape. All bags come prefilled with weight so no filling required

SKU	DESCRIPTION	WEIGHT	CARTON SIZE
TD-SB-KEP-10LB	KEVLAR SAND BAG	10 LBS	7.5 X 7.5 X 20 INCH
TD-SB-KEP-20LB	KEVLAR SAND BAG	20 LBS	8.5 X 8.5 X 21 INCH
TD-SB-KEP-30LB	KEVLAR SAND BAG	30 LBS	9 X 9 X 23 INCH
TD-SB-KEP-40LB	KEVLAR SAND BAG	40 LBS	9.5 X 9.5 X 25 INCH
TD-SB-KEP-50LB	KEVLAR SAND BAG	50 LBS	10 X 10 X 27 INCH



14" TACTEC KEVLAR® MEDICINE BALL

Our medicine ball features a new cover constructed of high tensile TacTec™ Kevlar®, delivering increased durability and grip when compared to traditional medicine balls.

SKU	DESCRIPTION	WEIGHT	CARTON SIZE
TD-MB-TAC-14IN-4LB	XD MEDICINE BALL KEVLAR	4LB	18 X 18 X 19 INCH
TD-MB-TAC-14IN-6LB	XD MEDICINE BALL KEVLAR	6LB	18 X 18 X 19 INCH
TD-MB-TAC-14IN-8LB	XD MEDICINE BALL KEVLAR	8LB	18 X 18 X 19 INCH
TD-MB-TAC-14IN-10LB	XD MEDICINE BALL KEVLAR	10LB	18 X 18 X 19 INCH
TD-MB-TAC-14IN-12LB	XD MEDICINE BALL KEVLAR	12LB	18 X 18 X 19 INCH
TD-MB-TAC-14IN-14LB	XD MEDICINE BALL KEVLAR	14LB	18 X 18 X 19 INCH
TD-MB-TAC-14IN-16LB	XD MEDICINE BALL KEVLAR	16LB	18 X 18 X 19 INCH
TD-MB-TAC-14IN-18LB	XD MEDICINE BALL KEVLAR	18LB	18 X 18 X 19 INCH
TD-MB-TAC-14IN-20LB	XD MEDICINE BALL KEVLAR	20LB	18 X 18 X 19 INCH
TD-MB-TAC-14IN-25LB	XD MEDICINE BALL KEVLAR	25LB	18 X 18 X 19 INCH
TD-MB-TAC-14IN-30LB	XD MEDICINE BALL KEVLAR	30LB	18 X 18 X 19 INCH



14" KEPROTEC® KEVLAR® MEDICINE BALL

The toughest and only reinforced medicine ball with DuPont™ Kevlar® fiber on the market. This extremely durable and low-bounce ball keeps its shape due to its patented construction. Perfect for the large variety of exercises preformed by athletes of all types.

SKU	DESCRIPTION	WEIGHT	CARTON SIZE
TD-MB-KEP-14IN-4LB	KEVLAR MEDICINE BALL	4 LB	14 X 14 X 14.5 INCH
TD-MB-KEP-14IN-6LB	KEVLAR MEDICINE BALL	6 LB	14 X 14 X 14.5 INCH
TD-MB-KEP-14IN-8LB	KEVLAR MEDICINE BALL	8 LB	14 X 14 X 14.5 INCH
TD-MB-KEP-14IN-10LB	KEVLAR MEDICINE BALL	10 LB	14 X 14 X 14.5 INCH
TD-MB-KEP-14IN-12LB	KEVLAR MEDICINE BALL	12 LB	14 X 14 X 14.5 INCH
TD-MB-KEP-14IN-14LB	KEVLAR MEDICINE BALL	14 LB	14 X 14 X 14.5 INCH
TD-MB-KEP-14IN-16LB	KEVLAR MEDICINE BALL	16 LB	14 X 14 X 14.5 INCH
TD-MB-KEP-14IN-18LB	KEVLAR MEDICINE BALL	18 LB	14 X 14 X 14.5 INCH
TD-MB-KEP-14IN-20LB	KEVLAR MEDICINE BALL	20 LB	14 X 14 X 14.5 INCH
TD-MB-KEP-14IN-25LB	KEVLAR MEDICINE BALL	25 LB	14 X 14 X 14.5 INCH
TD-MB-KEP-14IN-30LB	KEVLAR MEDICINE BALL	30 LB	14 X 14 X 14.5 INCH
TD-MB-KEP-14IN-35LB	KEVLAR MEDICINE BALL	35 LB	14 X 14 X 14.5 INCH
TD-MB-KEP-14IN-40LB	KEVLAR MEDICINE BALL	40 LB	14 X 14 X 14.5 INCH
TD-MB-KEP-14IN-45LB	KEVLAR MEDICINE BALL	45 LB	14 X 14 X 14.5 INCH
TD-MB-KEP-14IN-50LB	KEVLAR MEDICINE BALL	50 LB	14 X 14 X 14.5 INCH



KEVLAR® RUBBER MEDICINE BALL

This uniquely designed medicine ball is one of a kind. We used tire technology to combine the best natural rubber with DuPont™ Kevlar® fiber making this the most durable medicine ball on the market. This is truly an evolution in a product that hasn't seen progress in decades. Unique custom pattern provides grippy texture to aid in catching, throwing, slamming, or moving with the ball in general. This ball has a medium bounce to it and is not a dead bounce slam ball.

SKU	DESCRIPTION	WEIGHT	CARTON SIZE
TD-RMB-KEV-4LB	XD RUBBER MED BALL WITH KEVLAR	4LB	11.3 X 11.3 X 11.3 INCH
TD-RMB-KEV-6LB	XD RUBBER MED BALL WITH KEVLAR	6LB	11.3 X 11.3 X 11.3 INCH
TD-RMB-KEV-8LB	XD RUBBER MED BALL WITH KEVLAR	8LB	11.3 X 11.3 X 11.3 INCH
TD-RMB-KEV-10LB	XD RUBBER MED BALL WITH KEVLAR	10LB	11.3 X 11.3 X 11.3 INCH
TD-RMB-KEV-12LB	XD RUBBER MED BALL WITH KEVLAR	12LB	11.3 X 11.3 X 11.3 INCH
TD-RMB-KEV-15LB	XD RUBBER MED BALL WITH KEVLAR	15LB	11.3 X 11.3 X 11.3 INCH
TD-RMB-KEV-20LB	XD RUBBER MED BALL WITH KEVLAR	20LB	11.3 X 11.3 X 11.3 INCH
TD-RMB-KEV-25LB	XD RUBBER MED BALL WITH KEVLAR	25LB	11.3 X 11.3 X 11.3 INCH
TD-RMB-KEV-30LB	XD RUBBER MED BALL WITH KEVLAR	30LB	11.3 X 11.3 X 11.3 INCH

FREE WEIGHTS

Throwdown offers a wide variety of products to ensure you have everything you need to fully outfit your free weight area. Every product meets our high-quality standard and is made with premium hard-wearing materials.

Throwdown Free Weights pair perfectly with Nautilus Strength products allowing you to get everything in one place. You can even find free weight sets crafted specifically for popular Nautilus Benches & Racks, Leverage and Plate Loaded products.





URETHANE DUMBBELLS, EZ CURL AND STRAIGHT BARBELLS



With solid steel heads, premium hard-wearing urethane coating, stainless steel ring at joint and stainless steel grips Throwdown's dumbbells are built to withstand the toughest workouts.

URETHANE BUMPER PLATES



Throwdown's Urethane Bumper Plates are produced with precision casting, large hard chrome plated hubs, premium hard-wearing urethane coatings and beveled edges for easy pickup.

URETHANE OLYMPIC PLATES



Throwdown's Urethane Olympic Plates feature a solid stainless steel insert, precision casting and a premium hard-wearing urethane coating.



URETHANE DUMBBELLS

- Solid steel heads
- Premium hard-wearing urethane coating
- Stainless steel ring at joint
- Stainless steel grips (5-20 lb are 29 mm, 25-125 lb are 35 mm diameter grips.)
- Head Diameter (5-15 lb are 126mm, 20-30 lb are 155mm, 35-125 lb are 205mm)

URETHANE DUMBBELL - SETS LB

5 - 25 lb Set	WT	5 lb	10 lb	15 lb	20 lb	25 lb
9-SMLB-60THD	QTY	1 pair	1 pair	1 pair	1 pair	1 pair
30 - 50 lb Set	WT	30 lb	35 lb	40 lb	45 lb	50 lb
9-MDLB-60THD	QTY	1 pair	1 pair	1 pair	1 pair	1 pair
55 - 75 lb Set	WT	55 lb	60 lb	65 lb	70 lb	75 lb
9-LGLB-60THD	QTY	1 pair	1 pair	1 pair	1 pair	1 pair
80 - 100 lb Set	WT	80 lb	85 lb	90 lb	95 lb	100 lb
9-XLLB-60THD	QTY	1 pair	1 pair	1 pair	1 pair	1 pair
7.5 - 27.5 lb Set	WT	7.5 lb	12.5 lb	17.5 lb	22.5 lb	27.5 lb
9-S2LB-60THD	QTY	1 pair	1 pair	1 pair	1 pair	1 pair
32.5 - 52.5 lb Set	WT	32.5 lb	37.5 lb	42.5 lb	47.5 lb	52.5 lb
9-M2LB-60THD	QTY	1 pair	1 pair	1 pair	1 pair	1 pair
5 - 100 lb Club Set (4 Sets)				9-UDC2-CLUBLB-60THD		

URETHANE DUMBBELLS - SINGLE LB

UDC2-105LB-60THD	WT	105 lb
UDC2-110LB-60THD	WT	110 lb
UDC2-115LB-60THD	WT	115 lb
UDC2-120LB-60THD	WT	120 lb
UDC2-125LB-60THD	WT	125 lb

URETHANE DUMBBELL - SETS KG

2.5 - 12.5 KG Set	WT	2.5 KG	5 KG	7.5 KG	10 KG	12.5 KG
9-SMKG-60THD	QTY	1 pair	1 pair	1 pair	1 pair	1 pair
15 - 25 KG Set	WT	15 KG	17.5 KG	20 KG	22.4 KG	25 KG
9-MDKG-60THD	QTY	1 pair	1 pair	1 pair	1 pair	1 pair
27.5 - 37.5 Set	WT	27.5 KG	30 KG	32.5 KG	35 KG	37.5 KG
9-LGKG-60THD	QTY	1 pair	1 pair	1 pair	1 pair	1 pair
40 - 50 KG Set	WT	40 KG	42.5 KG	45 KG	47.5	50 KG
9-XLKG-60THD	QTY	1 pair	1 pair	1 pair	1 pair	1 pair
1 - 5 KG Set	WT	1 KG	2 KG	3 KG	4 KG	5 KG
9-S2KG-60THD	QTY	1 pair	1 pair	1 pair	1 pair	1 pair
6 - 10 KG Set	WT	6 KG	7 KG	8 KG	9 KG	10 KG
9-M2KG-60THD	QTY	1 pair	1 pair	1 pair	1 pair	1 pair
2.5 - 50KG Club Set (4 Sets)				9-UDC2-CLUBKG-60THD		

URETHANE DUMBBELLS - SINGLE KG

UDC2-52.5KG-60THD	WT	52.5 KG
UDC2-55KG-60THD	WT	55 KG
UDC2-57.5KG-60THD	WT	57.5 KG
UDC2-60KG-60THD	WT	60 KG
UDC2-62.5KG-60THD	WT	62.5 KG
UDC2-65KG-60THD	WT	65 KG
UDC2-67.5KG-60THD	WT	67.5 KG
UDC2-70KG-60THD	WT	70 KG
UDC2-72.5KG-60THD	WT	72.5 KG
UDC2-75KG-60THD	WT	75 KG



URETHANE OLYMPIC PLATES

- Solid stainless steel insert
- Precision casting
- Premium hard-wearing urethane coating

URETHANE OLYMPIC PLATE - SETS LB							
Benches & Racks Set	WT	2.5 lb	5 lb	10 lb	25 lb	35 lb	45 lb
9-UPR2-BRCLB-60THD	QTY	2 each	2 each	4 each	4 each	2 each	6 each
Leverage Set	WT	10 lb	25 lb	45 lb			
9-UPR2-LVRLB-60THD	QTY	2 each	4 each	4 each			
Weight Tree Add-on Set	WT	2.5 lb	5 lb	35 lb			
9-UPR2-SMLB-60THD	QTY	2 each	2 each	2 each			
4-Sided Weight Tree Set	WT	2.5 lb	5 lb	10 lb	25 lb	35 lb	45 lb
9-UPR2-4WTLB-60THD	QTY	4 each	4 each	4 each	4 each	4 each	6 each

URETHANE OLYMPIC PLATES - SINGLE LB		
UPR2-2.5LB-60THD	WT	2.5 lb
UPR2-05LB-60THD	WT	5 lb
UPR2-10LB-60THD	WT	10 lb
UPR2-25LB-60THD	WT	25 lb
UPR2-35LB-60THD	WT	35 lb
UPR2-45LB-60THD	WT	45 lb

URETHANE OLYMPIC PLATE - SETS								
200 KG Set	WT	1.25 KG	2.5 KG	5 KG	10 KG	15 KG	20 KG	25 KG
9-UPR2-200KG-60THD	QTY	8 each	4 each	4 each	4 each	2 each	2 each	2 each
100KG Add-on Set	WT	2.5 KG	10 KG	15 KG	20 KG			
9-UPR2-SMKTKG-60THD	QTY	4 each	2 each	2 each	2 each			
200KG Add-on Set	WT	2.5 KG	15 KG	20 KG	25 KG			
9-UPR2-MDKTKG-60THD	QTY	4 each	4 each	4 each	2 each			
300KG Add-on Set	WT	5 KG	15 KG	20 KG	25 KG			
9-UPR2-LGKTKG-60THD	QTY	4 each	4 each	6 each	4 each			
300KG Set	WT	1.25 KG	2.5 KG	5 KG	10 KG	15 KG	20 KG	25 KG
9-UPR2-300KG-60THD	QTY	8 each	8 each	4 each	6 each	4 each	4 each	2 each
400KG Set	WT	1.25 KG	2.5 KG	5 KG	10 KG	15 KG	20 KG	25 KG
9-UPR2-400KG-60THD	QTY	8 each	8 each	4 each	4 each	6 each	6 each	4 each
1000KG Set	WT	1.25 KG	2.5 KG	5 KG	10 KG	15 KG	20 KG	25 KG
9-UPR2-1000KG-60THD	QTY	16 each	16 each	16 each	10 each	10 each	16 each	10 each

URETHANE OLYMPIC PLATES - SINGLE KG		
UPR2-1.25KG-60THD	WT	1.25 KG
UPR2-2.5KG-60THD	WT	2.5 KG
UPR2-05KG-60THD	WT	5 KG
UPR2-10KG-60THD	WT	10 KG
UPR2-15KG-60THD	WT	15 KG
UPR2-20KG-60THD	WT	20 KG
UPR2-25KG-60THD	WT	25 KG

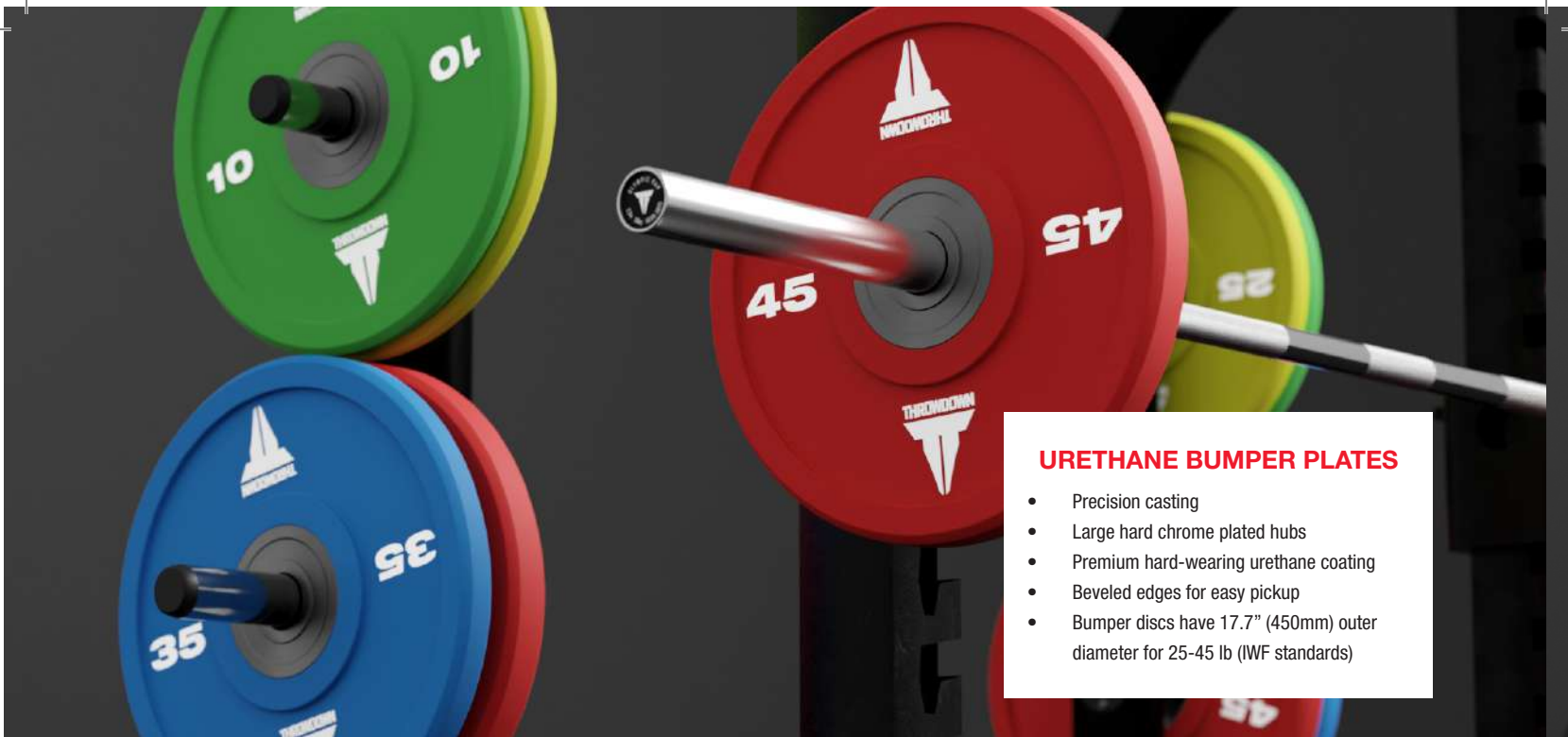

URETHANE BUMPER PLATES

- Precision casting
- Large hard chrome plated hubs
- Premium hard-wearing urethane coating
- Beveled edges for easy pickup
- Bumper discs have 17.7" (450mm) outer diameter for 25-45 lb (IWF standards)

URETHANE BUMPER PLATE - SETS

Platform Set	WT	10 lb	25 lb	35 lb	45 lb
9-UBP2-PLTLB-THD	QTY	2 each	2 each	2 each	2 each
Glute Drive Set	WT	10 lb	25 lb	45 lb	
9-UBP2-GLTLB-THD	QTY	4 each	2 each	4 each	

URETHANE BUMPER PLATES - SINGLE

UBP2-10LB-THD	WT	10 lb
UBP2-25LB-THD	WT	25 lb
UBP2-35LB-THD	WT	35 lb
UBP2-45LB-THD	WT	45 lb

URETHANE BUMPER PLATE - SETS

Standard Set	WT	5 KG	10 KG	15 KG	20 KG	25 KG
9-UBP2-SETKG-THD	QTY	2 each	2 each	2 each	2 each	2 each
50KG Add-on Set	WT	5 KG	10 KG			
9-UBP2-SMKTG-THD	QTY	2 each	4 each			
Glute Drive Set	WT	5 KG	10 KG	20 KG		
9-UBP2-GLTKG-THD	QTY	2 each	2 each	2 each		
500KG Set	WT	5 KG	10 KG	15 KG	20 KG	25 KG
9-UBP2-500KG-THD	QTY	8 each	10 each	6 each	6 each	6 each

URETHANE BUMPER PLATES - SINGLE

UBP2-05KG-THD	WT	5 KG
UBP2-10KG-THD	WT	10 KG
UBP2-15KG-THD	WT	15 KG
UBP2-20KG-THD	WT	20 KG
UBP2-25KG-THD	WT	25 KG



BEAUTY BELLS

- Straight knurled handles
- Chrome finish
- Stamped weight increments

BEAUTY BELL SET

Beauty Bell Set	WT	5 lb	8 lb	10 lb	12 lb	15 lb
9-CDF2LB	QTY	3 pair	3 pair	2 pair	2 pair	2 pair

BEAUTY BELL SET

Beauty Bell Set	WT	1 KG	2 KG	3 KG	4 KG	5 KG	6 KG	7 KG	8 KG	9 KG	10 KG
9-CDF2KG	QTY	1 pair	1 pair	1 pair	1 pair	1 pair	1 pair	1 pair	1 pair	2 pair	2 pair

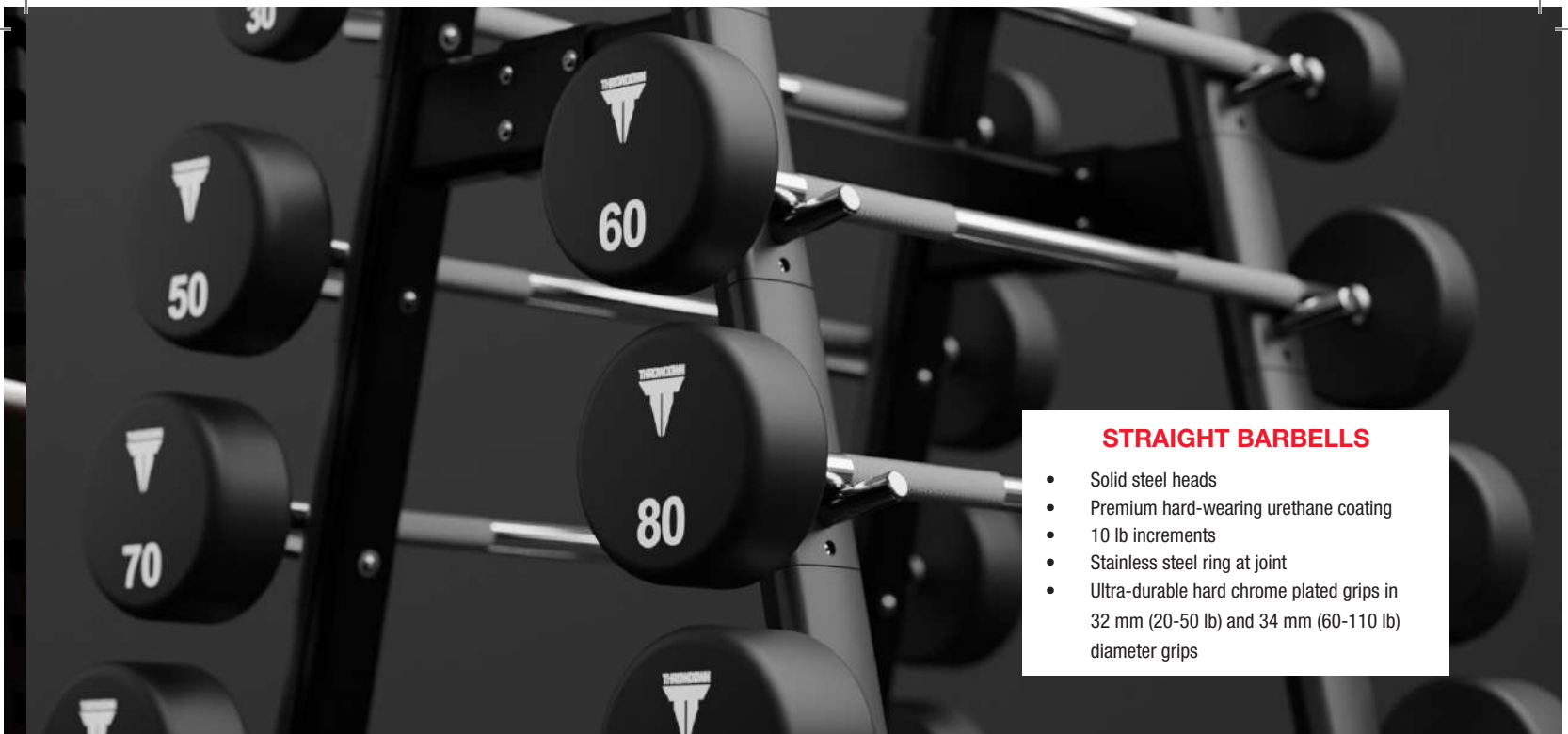

STRAIGHT BARBELLS

- Solid steel heads
- Premium hard-wearing urethane coating
- 10 lb increments
- Stainless steel ring at joint
- Ultra-durable hard chrome plated grips in 32 mm (20-50 lb) and 34 mm (60-110 lb) diameter grips

STRAIGHT BARBELL SET

Straight Barbell Set	WT	10 KG	12.5 KG	15 KG	17.5 KG	20 KG	25 KG	30 KG	35 KG	40 KG	45 KG
9-UBS2-CLUBKG-60THD	QTY	1 each	1 each	1 each	1 each	1 each	1 each	1 each	1 each	1 each	1 each

STRAIGHT BARBELL SET

Straight Barbell Set	WT	20 lb	30 lb	40 lb	50 lb	60 lb	70 lb	80 lb	90 lb	100 lb	110 lb
9-UBS2-CLUBLB-60THD	QTY	1 each	1 each	1 each	1 each	1 each	1 each	1 each	1 each	1 each	1 each



EZ CURL BARBELLS

- Solid steel heads
- Premium hard-wearing urethane coating
- 10 lb increments
- Stainless steel ring at joint
- Ultra-durable hard chrome plated grips in 32 mm (20-50 lb) and 34 mm (60-110 lb) diameter grips

EZ CURL BARBELL SET

EZ Curl Barbell Set	WT	10 KG	12.5 KG	15 KG	17.5 KG	20 KG	25 KG	30 KG	35 KG	40 KG	45 KG
9-UBC2-CLUBKG-60THD	QTY	1 each	1 each	1 each	1 each	1 each	1 each	1 each	1 each	1 each	1 each

EZ CURL BARBELL SET

EZ Curl Barbell Set	WT	20 lb	30 lb	40 lb	50 lb	60 lb	70 lb	80 lb	90 lb	100 lb	110 lb
9-UBC2-CLUBLB-60THD	QTY	1 each	1 each	1 each	1 each	1 each	1 each	1 each	1 each	1 each	1 each

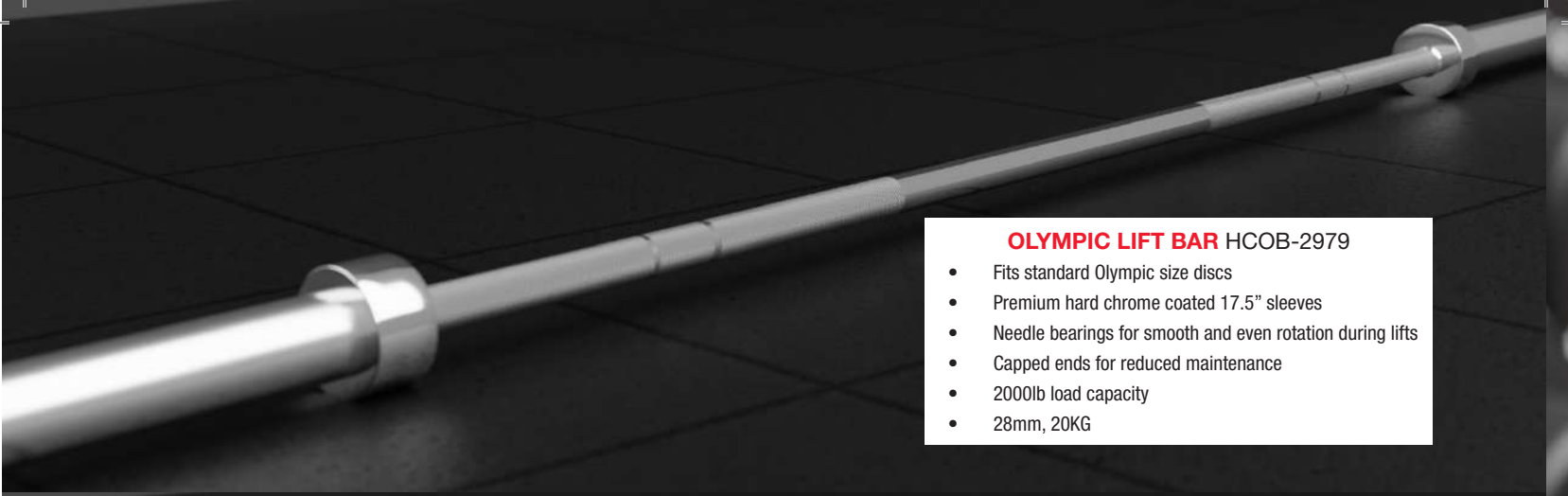

OLYMPIC LIFT BAR HCOB-2979

- Fits standard Olympic size discs
- Premium hard chrome coated 17.5" sleeves
- Needle bearings for smooth and even rotation during lifts
- Capped ends for reduced maintenance
- 2000lb load capacity
- 28mm, 20KG

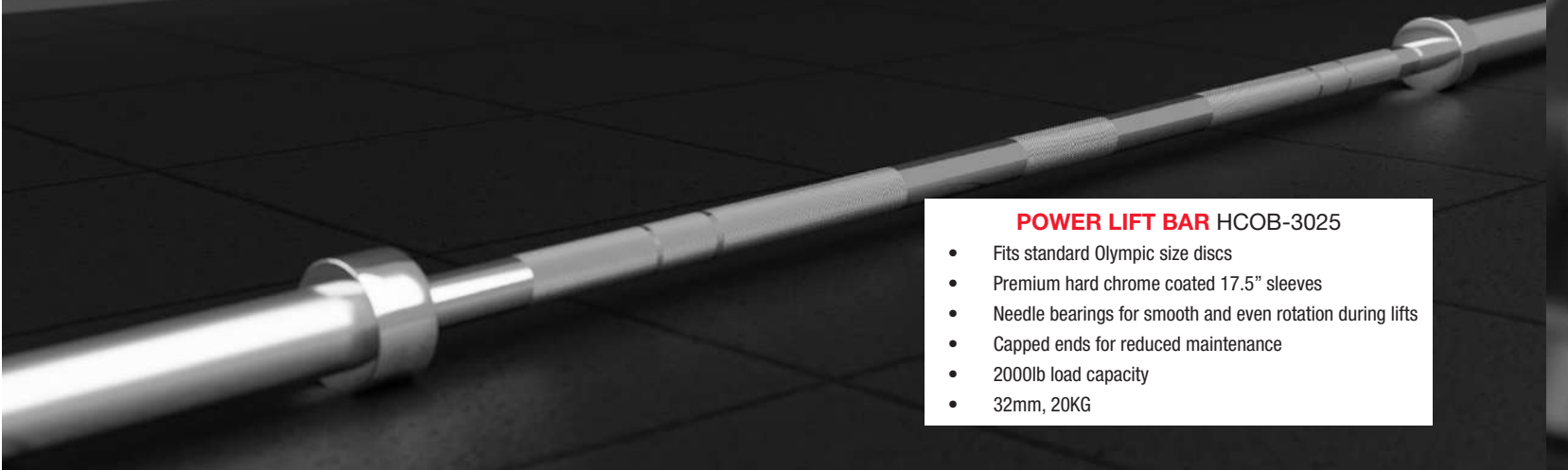

POWER LIFT BAR HCOB-3025

- Fits standard Olympic size discs
- Premium hard chrome coated 17.5" sleeves
- Needle bearings for smooth and even rotation during lifts
- Capped ends for reduced maintenance
- 2000lb load capacity
- 32mm, 20KG

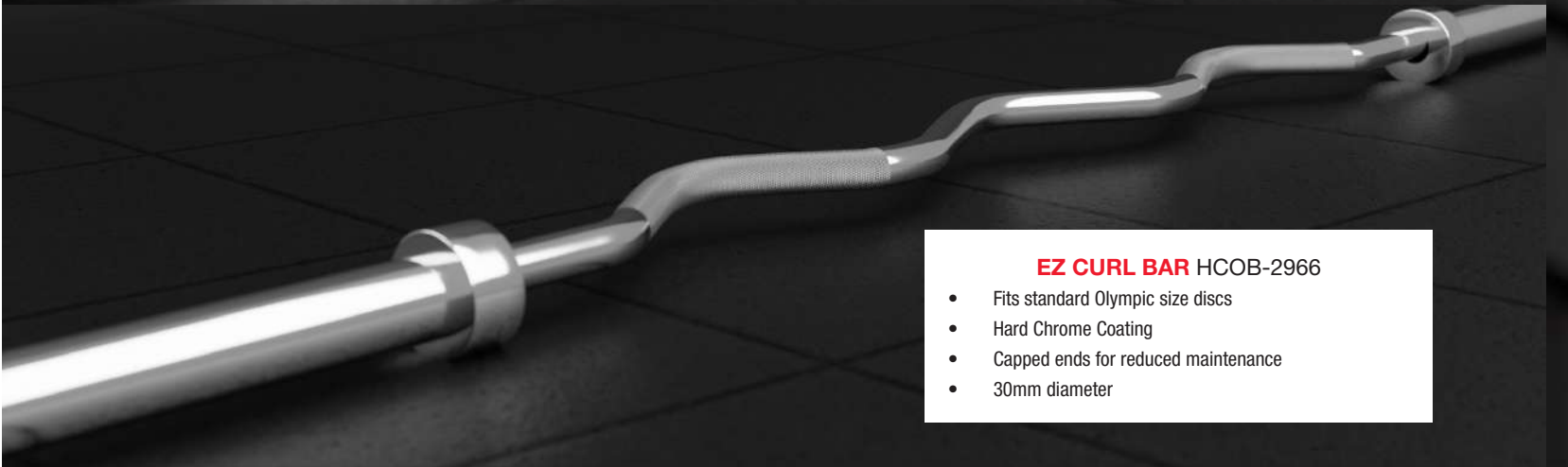

EZ CURL BAR HCOB-2966

- Fits standard Olympic size discs
- Hard Chrome Coating
- Capped ends for reduced maintenance
- 30mm diameter

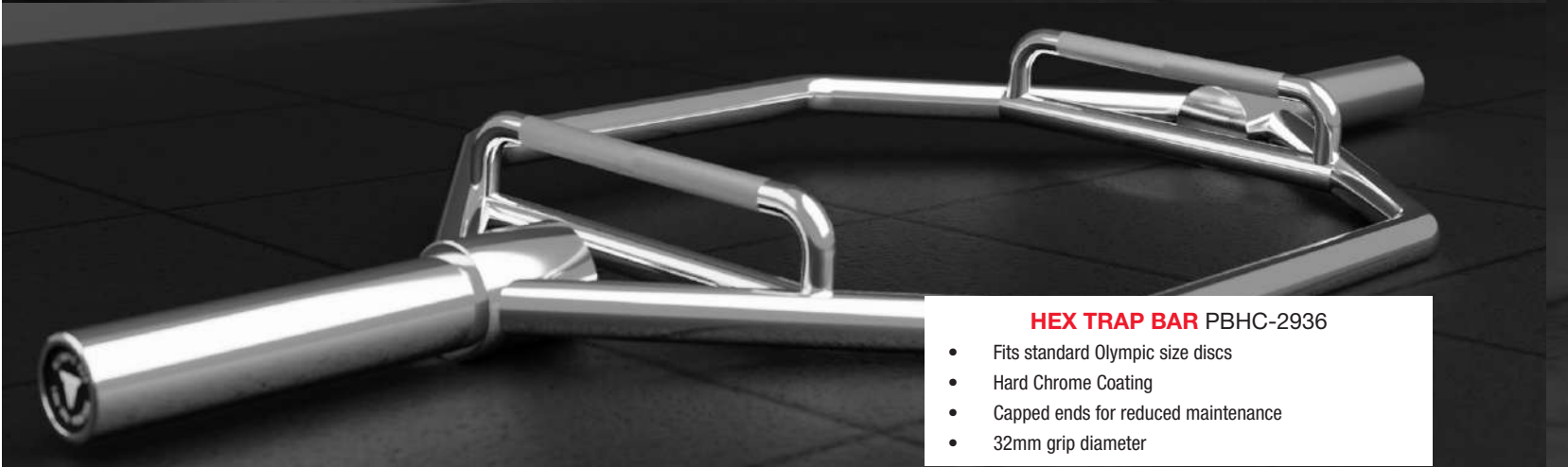

HEX TRAP BAR PBHC-2936

- Fits standard Olympic size discs
- Hard Chrome Coating
- Capped ends for reduced maintenance
- 32mm grip diameter



CUSTOMIZATION

Brand is everything. And now, you can make an even longer lasting impression with customized free weights. With custom colored urethane and up to 2-color logos on weights, plates, dumbbells and barbells you can enhance your brand. Put your best foot forward with Throwdown custom free weights.



With the invention of strength training machines, Nautilus brought fitness to the masses. Focusing on biomechanics that complement natural human movements, Nautilus makes weightlifting approachable to people at all fitness levels. The authentic approach to building muscle that started 50 years ago is still true today with essential equipment recognized in strength training programs worldwide.

SECTION 4



TRUSTED STRENGTH

WHAT WE'RE KNOWN FOR

- High quality products
- A reputable, trustworthy company
- Has reliable products with high uptime
- The equipment used by serious enthusiasts
- The equipment used in higher end gyms





NAUTILUS ONE

Nautilus One™ equipment combines revolutionary weight stack technology, a 4-bar linkage and specialized CAM designs to provide users with smooth resistance and proper muscle loading through the complete range of motion and the most intuitive and user-friendly selection method ever created: a dial. Fewer cams, pulleys and no guide rods extend the life of this product well past other machines.





INNOVATIVE WEIGHT SELECT DIAL



Nautilus selectorized strength has some of the most innovative and easy to use weight selection systems ever. The weight dial featured on the One product line removes the need for pins and lanyards, which can easily be lost or broken, meaning fewer maintenance headaches. The dial works with an adjustable incremental weight selection. Members will love this intuitive weight adjustment, which is within reach from a seated position.

MODERN TOWER DESIGN



Nautilus One towers are genius in their simplicity. Unlike traditional weight stacks, plates are stacked side-by-side with minimal use of pulleys and belts. This allows for natural movement mechanics and gives a smooth, plate-loaded workout feel from a selectorized machine. The elimination of guide rods results in less friction, smoother motion, less noise and no maintenance. Plus, the uniform, low profile (47") tower improves line of site and provides a cleaner looking circuit and optional weight systems can be configured to meet the needs of your facility.

PRODUCT CUSTOMIZATION



Make a stronger first impression with custom strength equipment from Nautilus. We have a wide variety of options to help you match the look of your strength equipment to your personal brand, with the ability to create custom colored upholstery, frames and even design custom shrouds with your logo, on select strength lines.

[SEE PAGE 113 FOR MORE DETAILS](#)



ROW S6MR

W	54 IN (137 CM)
L	62 IN (157 CM)
H	47 IN (119 CM)
STACK WEIGHT	250 LB (125 KG)
OVERALL WEIGHT	727 LB (330 KG)
SHIPPING WEIGHT	849 LB (385 KG)

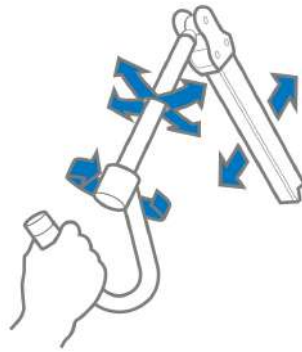

ERGO GRIP TECHNOLOGY

Ergo Grip technology provides complete and independent arm movement enabling a natural, user-defined path of motion.



LAT PULLDOWN S6LATP

W	51 IN (130 CM)
L	72 IN (183 CM)
H	87 IN (221 CM)
STACK WEIGHT	250 LB (125 KG)
OVERALL WEIGHT	780 LB (354 KG)
SHIPPING WEIGHT	913 LB (414 KG)



CHEST PRESS S6CP

W	64 IN (163 CM)
L	58 IN (147 CM)
H	75 IN (191 CM)
STACK WEIGHT	250 LB (125 KG)
OVERALL WEIGHT	745 LB (338 KG)
SHIPPING WEIGHT	865 LB (393 KG)



SHOULDER PRESS S6SP

W	64 IN (163 CM)
L	59 IN (150 CM)
H	62 IN (157 CM)
STACK WEIGHT	250 LB (125 KG)
OVERALL WEIGHT	751 LB (341 KG)
SHIPPING WEIGHT	891 LB (404 KG)



BICEP CURL S6BC

W	63 IN (160 CM)
L	51 IN (130 CM)
H	51 IN (130 CM)
STACK WEIGHT	250 LB (125 KG)
OVERALL WEIGHT	708 LB (321 KG)
SHIPPING WEIGHT	840 LB (381 KG)



ABDOMINAL CRUNCH S6AB

W	55 IN (140 CM)
L	53 IN (135 CM)
H	59 IN (150 CM)
STACK WEIGHT	250 LB (125 KG)
OVERALL WEIGHT	760 LB (345 KG)
SHIPPING WEIGHT	869 LB (394 KG)



TRICEP PRESS S6TP

W	58 IN (147 CM)
L	59 IN (150 CM)
H	47 IN (119 CM)
STACK WEIGHT	250 LB (125 KG)
OVERALL WEIGHT	815 LB (370 KG)
SHIPPING WEIGHT	851 LB (386 KG)



FOUR-WAY NECK MACHINE S6FWN

W	64 IN (163 CM)
L	46 IN (117 CM)
H	57 IN (145 CM)
STACK WEIGHT	250 LB (125 KG)
OVERALL WEIGHT	789 LB (358 KG)
SHIPPING WEIGHT	825 LB (375 KG)



LEG PRESS S6LP

W	51 IN (130 CM)
L	72 IN (183 CM)
H	57 IN (144 CM)
STACK WEIGHT	425 LB (200 KG)
OVERALL WEIGHT	1179 LB (535 KG)
SHIPPING WEIGHT	1314 LB (596 KG)



ROTARY TORSO S6RT

W	41 IN (104 CM)
L	71 IN (180 CM)
H	47 IN (119 CM)
STACK WEIGHT	250 LB (125 KG)
OVERALL WEIGHT	701 LB (318 KG)
SHIPPING WEIGHT	825 LB (375 KG)



LOW BACK S6LB

W	51 IN (130 CM)
L	50 IN (127 CM)
H	49 IN (124 CM)
STACK WEIGHT	250 LB (125 KG)
OVERALL WEIGHT	719 LB (326 KG)
SHIPPING WEIGHT	845 LB (384 KG)



HIP ABDUCTION/ADDUCTION S6AA

W	41 IN (104 CM)
L	87 IN (221 CM)
H	48 IN (122 CM)
STACK WEIGHT	250 LB (125 KG)
OVERALL WEIGHT	751 LB (341 KG)
SHIPPING WEIGHT	900 LB (408 KG)



SEATED LEG CURL S6LC

W	52 IN (132 CM)
L	64 IN (163 CM)
H	49 IN (124 CM)
STACK WEIGHT	250 LB (125 KG)
OVERALL WEIGHT	758 LB (344 KG)
SHIPPING WEIGHT	893 LB (405 KG)



LEG EXTENSION S6LE

W	52 IN (132 CM)
L	53 IN (135 CM)
H	49 IN (124 CM)
STACK WEIGHT	250 LB (125 KG)
OVERALL WEIGHT	729 LB (331 KG)
SHIPPING WEIGHT	864 LB (392 KG)

INSPIRATION

Proudly designed in the USA with beautiful, modern aesthetics and uniform towers, Nautilus Inspiration Strength® makes a powerful first impression.

Each machine captures the essence of natural movement. Members will appreciate the many easy to use and easy to see features like our patented Lock N Load® weight selection system, the wrap-around assisted seat adjustment, lenticular image placards, pre-stretch and range of motion controls designed to enhance each user's experience.



ROTARY TORSO IPRT5

W	58 IN (147 CM)
L	34 IN (86 CM)
H	64 IN (163 CM)
STACK WEIGHT	200 LB (91 KG)
OVERALL WEIGHT	560 LB (254 KG)
SHIPPING WEIGHT	655 LB (297 KG)



CHEST PRESS IPVP3

W	59 IN (150 CM)
L	43 IN (109 CM)
H	76 IN (193 CM)
STACK WEIGHT	240 LB (109 KG)
OVERALL WEIGHT	664 LB (301 KG)
SHIPPING WEIGHT	730 LB (331 KG)



LOCK N LOAD® WEIGHT SELECTION SYSTEM

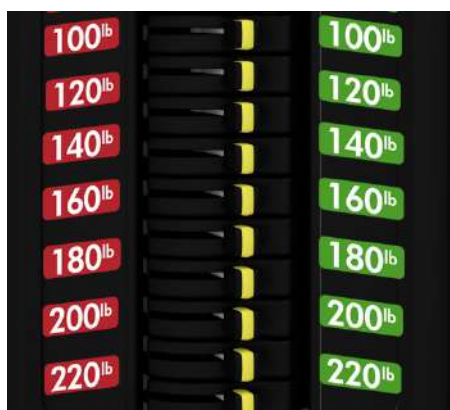

Nautilus selectorized strength has some of the most innovative and easy to use weight selection systems ever. Lock N Load® removes the need for pins, which can easily be lost or broken, meaning fewer maintenance headaches. Members will love the intuitive weight adjustment, which is as simple as flipping a switch.

ICONIC MOVEMENT



The iconic Nautilus pullover movement is now available in the Inspiration line. Dubbed the “Squat of the upper body” by Nautilus founder Arthur Jones, the pullover is a powerful machine that provides 250° of shoulder rotation, working the lats, pecs and abs.

PRODUCT CUSTOMIZATION



Make a stronger first impression with custom strength equipment from Nautilus. We have a wide variety of options to help you match the look of your strength equipment to your personal brand, with the ability to create custom colored upholstery, frames and even design custom shrouds with your logo, on select strength lines.

[SEE PAGE 113 FOR MORE DETAILS](#)



LEG EXTENSION IPLE5

W	48 IN (122 CM)
L	53 IN (135 CM)
H	64 IN (163 CM)
STACK WEIGHT	240 LB (109 KG)
OVERALL WEIGHT	717 LB (325 KG)
SHIPPING WEIGHT	800 LB (363 KG)



ABDOMINAL CRUNCH IPAC5

W	52 IN (132 CM)
L	51 IN (130 CM)
H	64 IN (163 CM)
STACK WEIGHT	200 LB (91 KG)
OVERALL WEIGHT	684 LB (310 KG)
SHIPPING WEIGHT	776 LB (352 KG)



LEG PRESS IPLP5

W	54 IN (137 CM)
L	74 IN (187 CM)
H	64 IN (163 CM)
STACK WEIGHT	400 LB (181 KG)
OVERALL WEIGHT	1,120 LB (508 KG)
SHIPPING WEIGHT	1,204 LB (546 KG)



LEG CURL IPLC5

W	46 IN (117 CM)
L	64 IN (163 CM)
H	64 IN (163 CM)
STACK WEIGHT	240 LB (109 KG)
OVERALL WEIGHT	743 LB (337 KG)
SHIPPING WEIGHT	833 LB (378 KG)



ABDUCTION/ ADDUCTION IPAA5

W	55 IN (140 CM)
L	56 IN (142CM)
H	64 IN (163 CM)
STACK WEIGHT	200 LB (91 KG)
OVERALL WEIGHT	657 LB (298 KG)
SHIPPING WEIGHT	734 LB (333 KG)



GLUTE PRESS IPGM5

W	45 IN (114 CM)
L	75 IN (191 CM)
H	64 IN (163 CM)
STACK WEIGHT	240 LB (109 KG)
OVERALL WEIGHT	600 LB (272 KG)
SHIPPING WEIGHT	679 LB (308 KG)



TRICEP DIP IPTD5

W	52 IN (132 CM)
L	51 IN (130 CM)
H	64 IN (163 CM)
STACK WEIGHT	240 LB (109 KG)
OVERALL WEIGHT	750 LB (340 KG)
SHIPPING WEIGHT	831 LB (377 KG)



**DUAL ADJUSTABLE PULLEY
NP-D9302**

W	62 IN (157 CM)
L	46 IN (117 CM)
H	88 IN (224 CM)
STACK WEIGHT	2 X 400 LB (2 X 181 KG) 2 X 100 LB (AT HANDLE)
OVERALL WEIGHT	1,308 LB (593 KG)
SHIPPING WEIGHT	1,394 LB (632 KG)



BICEPS CURL IPBC5

W	56 IN (142 CM)
L	45 IN (114 CM)
H	64 IN (163 CM)
STACK WEIGHT	200 LB (91 KG)
OVERALL WEIGHT	613 LB (278 KG)
SHIPPING WEIGHT	699 LB (317 KG)



LAT PULL DOWN IPPD5

W	55 IN (140 CM)
L	55 IN (140 CM)
H	77 IN (196 CM)
STACK WEIGHT	240 LB (109 KG)
OVERALL WEIGHT	715 LB (324 KG)
SHIPPING WEIGHT	805 LB (365 KG)



VERTICAL ROW IPVR5

W	50 IN (127 CM)
L	45 IN (114 CM)
H	77 IN (196 CM)
STACK WEIGHT	240 LB (108 KG)
OVERALL WEIGHT	690 LB (313 KG)
SHIPPING WEIGHT	772 LB (350 KG)



PULL OVER IPPO5

W	58 IN (147 CM)
L	58 IN (147 CM)
H	64 IN (163 CM)
STACK WEIGHT	200 LB (91 KG)
OVERALL WEIGHT	693 LB (314 KG)
SHIPPING WEIGHT	783 LB (355 KG)



PEC FLY/ REAR DELTOID IPPF5

W	58 IN (147 CM)
L	46 IN (117 CM)
H	80 IN (203 CM)
STACK WEIGHT	240 LB (109 KG)
OVERALL WEIGHT	706 LB (320 KG)
SHIPPING WEIGHT	798 LB (362 KG)



SHOULDER PRESS IPSP5

W	58 IN (147 CM)
L	60 IN (152 CM)
H	64 IN (163 CM)
STACK WEIGHT	200 LB (91 KG)
OVERALL WEIGHT	609 LB (276 KG)
SHIPPING WEIGHT	697 LB (316 KG)



DELTOID RAISE IPDR5

W	52 IN (132 CM)
L	47 IN (119 CM)
H	64 IN (163 CM)
STACK WEIGHT	200 LB (91 KG)
OVERALL WEIGHT	618 LB (280 KG)
SHIPPING WEIGHT	686 LB (311 KG)



BILATERAL ARM CURL IPBA5

W	56 IN (142 CM)
L	45 IN (114 CM)
H	64 IN (163 CM)
STACK WEIGHT	200 LB (91 KG)
OVERALL WEIGHT	618 LB (280 KG)
SHIPPING WEIGHT	692 LB (314 KG)



TRICEP EXTENSION IPTe5

W	56 IN (142 CM)
L	43 IN (109 CM)
H	64 IN (163 CM)
STACK WEIGHT	200 LB (91 KG)
OVERALL WEIGHT	620 LB (281 KG)
SHIPPING WEIGHT	694 LB (315 KG)



BACK EXTENSION IPBE3

W	51 IN (130 CM)
L	50 IN (127 CM)
H	64 IN (163 CM)
STACK WEIGHT	200 LB (91 KG)
OVERALL WEIGHT	600 LB (272 KG)
SHIPPING WEIGHT	688 LB (312 KG)



IMPACT

The Impact® Strength line brings many subtle innovations to the power of your next weight training workout. It is the evolution of the proven biomechanics and user features that have made the Impact Strength line a solid, competitive product. This line retains all the unique, proven, individual design features that customers have stated are ideal, such as pre-stretch, start assist, range of motion selection and graduated heavy weight stacks. Impact Strength incorporates biomechanics features that have established its position as a competitive and diverse strength product line.





LOCK N LOAD® WEIGHT SELECTION SYSTEM

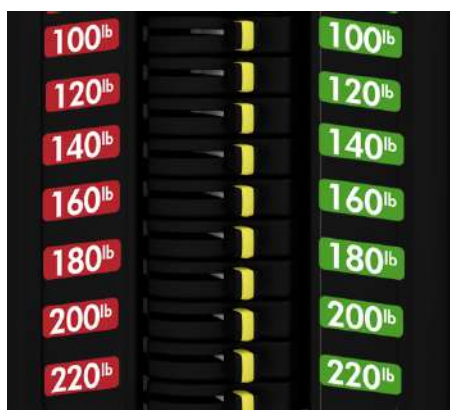

Nautilus selectorized strength has some of the most innovative and easy to use weight selection systems ever. Lock N Load® removes the need for pins, which can easily be lost or broken, meaning fewer maintenance headaches. Members will love the intuitive weight adjustment, which is as simple as flipping a switch.

SMOOTH OPERATORS



User friendly features like the ratcheting vertical seat adjustments and simple pop pin range of motion adjustments allow members to easily and effectively use the equipment.

REMEMBER THE STAPLES



The Chin Dip Assist has become a staple strength product because it allows the user to adjust their desired weight balance and build the muscles needed for these bodyweight exercises. With the innovative Lock N Load® weight stack and updates for an even more durable construction, this machine will be at home in any weight room.



SEATED LEG PRESS 9NA-S1305

W	47 IN (119 CM)
L	74 IN (187 CM)
H	65 IN (165 CM)
STACK WEIGHT	360 LB (180 KG)
OVERALL WEIGHT	968 LB (439 KG)
SHIPPING WEIGHT	1078 LB (489 KG)



SEATED LEG CURL 9NA-S1313

W	39 IN 99 CM)
L	70 IN (178 CM)
H	60 IN (152 CM)
STACK WEIGHT	260 LB (130 KG)
OVERALL WEIGHT	664 LB (301 KGS)
SHIPPING WEIGHT	732 LB (332 KGS)



KNEELING LEG CURL 9NA-S1311

W	44 IN (112 CM)
L	51 IN (130 CM)
H	60 IN (152 CM)
STACK WEIGHT	130 LB (65 KG)
OVERALL WEIGHT	434 LB (197 KG)
SHIPPING WEIGHT	505 LB (229 KG)



ABDUCTOR 9NA-S1307

W	48 IN (122 CM)
L	67.5 IN (171 CM)
H	60 IN (152 CM)
STACK WEIGHT	180 LB (90 KG)
OVERALL WEIGHT	543 LB (237 KG)
SHIPPING WEIGHT	613 LB (278 KG)



CHEST PRESS 9NA-S4301

W	52 IN (132 CM)
L	50 IN (127 CM)
H	60 IN (152 CM)
STACK WEIGHT	260 LB (130 KG)
OVERALL WEIGHT	596 LB (270 KG)
SHIPPING WEIGHT	666 LB (302 KG)



LEG EXTENSION 9NA-S1312

W	38 IN (145 CM)
L	57 IN (97 CM)
H	60 IN (152 CM)
STACK WEIGHT	260 LB (130 KG)
OVERALL WEIGHT	609 LB (276 KG)
SHIPPING WEIGHT	668 LB (303 KG)



LEG CURL 9NA-S1301

W	38 IN (97 CM)
L	71 IN (180 CM)
H	60 IN (152 CM)
STACK WEIGHT	180 LB (90 KG)
OVERALL WEIGHT	516 LB (234 KG)
SHIPPING WEIGHT	589 LB (267 KG)



ADDUCTOR 9NA-S1308

W	48 IN (122 CM)
L	67.5 IN (171 CM)
H	60 IN (152 CM)
STACK WEIGHT	180 LB (90 KG)
OVERALL WEIGHT	523 LB (237 KG)
SHIPPING WEIGHT	613 LB (278 KG)



STANDING CALF 9NA-S1309

W	49 IN (124 CM)
L	41 IN (104 CM)
H	62 IN (151 CM)
STACK WEIGHT	260 LB (130 KG)
OVERALL WEIGHT	635 LB (288 KG)
SHIPPING WEIGHT	706 LB (320 KG)



INCLINE PRESS 9NA-S2301

W	51 IN (130 CM)
L	75 IN (191 CM)
H	60 IN (152 CM)
STACK WEIGHT	260 LB (130 KG)
OVERALL WEIGHT	690 LB (313 KG)
SHIPPING WEIGHT	814 LB (369 KG)



DELTOID FLY 9NA-S4304

W	30 IN (76 CM)
L	50 IN (127 CM)
H	79 IN (201 CM)
STACK WEIGHT	220 LB (110 KG)
OVERALL WEIGHT	580 LB (263 KG)
SHIPPING WEIGHT	646 LB (293 KG)



LAT PULL DOWN 9NA-S3305

W	55 IN (140 CM)
L	47 IN (119 CM)
H	98 IN (249 CM)
STACK WEIGHT	260 LB (130 KG)
OVERALL WEIGHT	593 LB (269 KG)
SHIPPING WEIGHT	642 LB (291 KG)



LOW ROW 9NA-S3306

W	29 IN (72 CM)
L	90 IN (228.6 CM)
H	86 IN (218 CM)
STACK WEIGHT	260 LB (130 KGS)
OVERALL WEIGHT	565 LB (256 KGS)
SHIPPING WEIGHT	624 LB (283 KGS)



DELTOID RAISE 9NA-S4302

W	46 IN (117 CM)
L	51 IN (130 CM)
H	60 IN (152 CM)
STACK WEIGHT	130 LB (65 KG)
OVERALL WEIGHT	479 LB (217 KG)
SHIPPING WEIGHT	560 LB (254 KG)



TRICEP EXTENSION 9NA-S5302

W	46 IN (117 CM)
L	47 IN (119 CM)
H	60 IN (152 CM)
STACK WEIGHT	180 LB (90 KG)
OVERALL WEIGHT	499 LB (226 KG)
SHIPPING WEIGHT	580 LB (263 KG)



FIXED LAT PULL DOWN 9NA-S3303

W	43 IN (109 CM)
L	64 IN (163 CM)
H	80 IN (203 CM)
STACK WEIGHT	260 LB (130 KG)
OVERALL WEIGHT	673 LB (305 KG)
SHIPPING WEIGHT	754 LB (342 KG)



VERTICAL ROW 9NA-S3301

W	45 IN (114 CM)
L	62 IN (157 CM)
H	60 IN (152 CM)
STACK WEIGHT	260 LB (130 KG)
OVERALL WEIGHT	598 LB (271 KG)
SHIPPING WEIGHT	684 LB (310 KG)



SHOULDER PRESS 9NA-S4307

W	53 IN (135 CM)
L	64 IN (163 CM)
H	60 IN (152 CM)
STACK WEIGHT	260 LB (130 KG)
OVERALL WEIGHT	620 LB (281 KG)
SHIPPING WEIGHT	684 LB (310 KG)



BICEPS CURL 9NA-S5301

W	46 IN (117 CM)
L	58 IN (147 CM)
H	60 IN (152 CM)
STACK WEIGHT	180 LB (90 KG)
OVERALL WEIGHT	545 LB (247 KG)
SHIPPING WEIGHT	626 LB (284 KG)



DIP MACHINE 9NA-S5303

W	42 IN (107 CM)
L	55 IN (140 CM)
H	65 IN (165 CM)
STACK WEIGHT	260 LB (130 KG)
OVERALL WEIGHT	540 LB (245 KG)
SHIPPING WEIGHT	629 LB (285 KG)



CHIN DIP ASSIST 9NA-S6334

W	60 IN (152 CM)
L	50 IN (127 CM)
H	91 IN (231 CM)
STACK WEIGHT	200 LB (100 KG)
OVERALL WEIGHT	776 LB (352 KG)
SHIPPING WEIGHT	836 LB (379 KG)



LOW BACK 9NA-S3302

W	46 IN (117 CM)
L	53 IN (135 CM)
H	60 IN (152 CM)
STACK WEIGHT	260 LB (130 KG)
OVERALL WEIGHT	593 LB (269 KG)
SHIPPING WEIGHT	676 LB (306 KG)



ABDOMINAL 9NA-S6301

W	43 IN (109 CM)
L	59 IN (150 CM)
H	60 IN (152 CM)
STACK WEIGHT	130 LB (65 KG)
OVERALL WEIGHT	382 LB (173 KG)
SHIPPING WEIGHT	492 LB (223 KG)

PRODUCT CUSTOMIZATION

Make a stronger first impression with custom strength equipment from Nautilus. We have a wide variety of options to help you match the look of your strength equipment to your personal brand, with the ability to create custom colored upholstery, frames and even design custom shrouds with your logo, on select strength lines.

SEE PAGE 113 FOR MORE DETAILS





INSTINCT

Welcoming to users of all levels, Instinct® Strength is a full line of intuitive machines with easy adjustments, offering users a quick and complete workout. Perfectly suited to be a basic strength line or circuit system, Instinct effectively complements more specialized lines. Users can complete a circuit on their own or with the assistance of an instructor in just 30 minutes. Instinct Strength offers both single and dual function units to meet the needs of any space or facility. The versatility of Instinct's small footprint also lets you get the most from minimal space, while blending seamlessly with our cardio line for a cohesive facility look.





LOCK N LOAD® WEIGHT SELECTION SYSTEM

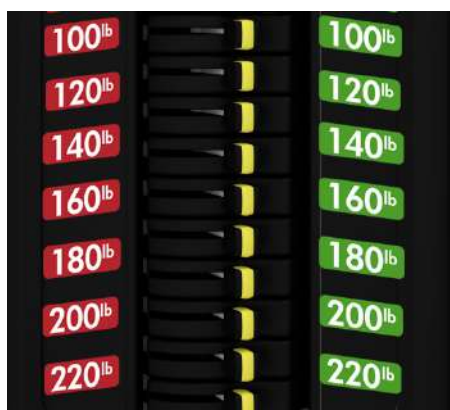

Nautilus selectorized strength has some of the most innovative and easy to use weight selection systems ever. Lock N Load® removes the need for pins, which can easily be lost or broken, meaning fewer maintenance headaches. Members will love the intuitive weight adjustment, which is as simple as flipping a switch.

A FULLY LOADED TOWER



Transparent weight towers create increased visibility and the Kevlar transmission belt provides extended life and easy replacement.

MAXIMIZING SPACE



Dual function machines allow for facilities with space limitations to get more great exercises in a smaller space. With multi-position grips, the innovative Lock N Load weight stack and simple switching between multiple exercises, Instinct gives you the most for your small footprint.



LEG EXTENSION 9NL-S1010

W	37 IN (94 CM)
L	41 IN (104 CM)
H	55 IN (140 CM)
STACK WEIGHT	190 LB (86 KG)
OVERALL WEIGHT	436 LB (198 KG)
SHIPPING WEIGHT	457 LB (207 KG)



DUAL ABDOMINAL/LOWER BACK 9NL-D6330

W	40 IN (102 CM)
L	45 IN (114 CM)
H	55 IN (140 CM)
STACK WEIGHT	120 LB (54 KG)
OVERALL WEIGHT	369 LB (168 KG)
SHIPPING WEIGHT	522 LB (237 KG)



LEG CURL 9NL-S1011

W	37 IN (94 CM)
L	56 IN (140 CM)
H	55 IN (140 CM)
STACK WEIGHT	190 LB (86 KG)
OVERALL WEIGHT	469 LB (213 KG)
SHIPPING WEIGHT	490 LB (222 KG)



DUAL LEG EXTENSION/LEG CURL 9NL-D1014

W	37 IN (94 CM)
L	56 IN (142 CM)
H	55 IN (140 CM)
STACK WEIGHT	190 LB (86 KG)
OVERALL WEIGHT	484 LB (220 KG)
SHIPPING WEIGHT	553 LB (251 KG)



DUAL LEG PRESS/CALF RAISE 9NL-D1013

W	39 IN (99 CM)
L	74 IN (188 CM)
H	55 IN (140 CM)
STACK WEIGHT	235 LB (107 KG)
OVERALL WEIGHT	612 LB (278 KG)
SHIPPING WEIGHT	689 LB (313 KG)



DUAL INNER/OUTER THIGH 9NL-D1015

W	27 IN (69 CM)
L	57 IN (145 CM)
H	55 IN (140 CM)
STACK WEIGHT	150 LB (68 KG)
OVERALL WEIGHT	451 LB (205 KG)
SHIPPING WEIGHT	520 LB (236 KG)



GLUTE PRESS 9NL-S1012

W	37 IN (94 CM)
L	67 IN (170 CM)
H	55 IN (140 CM)
STACK WEIGHT	120 LB (55 KG)
OVERALL WEIGHT	313 LB (142 KG)
SHIPPING WEIGHT	353 LB (160 KG)



CHEST PRESS 9NL-S2100

W	28 IN (71 CM)
L	49 IN (124 CM)
H	55 IN (140 CM)
STACK WEIGHT	235 LB (107 KG)
OVERALL WEIGHT	427 LB (194 KG)
SHIPPING WEIGHT	474 LB (215 KG)



DUAL MULTI-PRESS 9NL-D2120

W	55 IN (140 CM)
L	74 IN (188 CM)
H	55 IN (140 CM)
STACK WEIGHT	235 LB (107 KG)
OVERALL WEIGHT	506 LB (230 KG)
SHIPPING WEIGHT	576 LB (261 KG)



DUAL LAT PULL DOWN/VERTICAL ROW 9NL-D3340

W	47 IN (119 CM)
L	50 IN (127 CM)
H	84 IN (213 CM)
STACK WEIGHT	235 LB (107 KG)
OVERALL WEIGHT	473 LB (215 KG)
SHIPPING WEIGHT	540 LB (245 KG)



LAT PULL DOWN 9NL-S3310

W	47 IN (119 CM)
L	60 IN (152 CM)
H	73 IN (185 CM)
STACK WEIGHT	235 LB (107KG)
OVERALL WEIGHT	515 LB (234 KG)
SHIPPING WEIGHT	584 LB (265 KG)



VERTICAL ROW 9NL-S3320

W	46 IN (117 CM)
L	48 IN (122 CM)
H	55 IN (140 CM)
STACK WEIGHT	235 LB (107 KG)
OVERALL WEIGHT	405 LB (183 KG)
SHIPPING WEIGHT	452 LB (205 KG)



SHOULDER PRESS 9NL-S4100

W	53 IN (135 CM)
L	58 IN (147 CM)
H	55 IN (140 CM)
STACK WEIGHT	190 LB (86 KG)
OVERALL WEIGHT	448 LB (203 KG)
SHIPPING WEIGHT	496 LB (225 KG)



DUAL PECTORAL FLY/REAR DELTOID 9NL-D2110

W	50 IN (127 CM)
L	54 IN (137 CM)
H	79 IN (201 CM)
STACK WEIGHT	190 LB (86 KG)
OVERALL WEIGHT	426 LB (193 KG)
SHIPPING WEIGHT	497 LB (226 KG)



BICEPS CURL 9NL-S5100

W	39 IN (99 CM)
L	40 IN (102 CM)
H	55 IN (140 CM)
STACK WEIGHT	190 LB (86 KG)
OVERALL WEIGHT	416 LB (186 KG)
SHIPPING WEIGHT	450 LB (204 KG)



TRICEPS EXTENSION 9NL-S5110

W	39 IN (99 CM)
L	40 IN (102 CM)
H	55 IN (140 CM)
STACK WEIGHT	190 LB (86 KG)
OVERALL WEIGHT	421 LB (191 KG)
SHIPPING WEIGHT	454 LB (206 KG)



DUAL BICEPS CURL/TRICEPS EXTENSION 9NL-D5120

W	39 IN (99 CM)
L	52 IN (132 CM)
H	55 IN (140 CM)
STACK WEIGHT	190 LB (86 KG)
OVERALL WEIGHT	395 LB (180 KG)
SHIPPING WEIGHT	463 LB (210 KG)



ROTARY TORSO 9NL-S6300

W	38 IN (97 CM)
L	39 IN (99 CM)
H	55 IN 140 (CM)
STACK WEIGHT	190 LB (86 KG)
OVERALL WEIGHT	418 LB (190 KG)
SHIPPING WEIGHT	474 LB (215 KG)



**MULTI-ADJUSTABLE BENCH 100
9NN-B7506**

W	25 IN (64 CM)
L	61 IN (155 CM)
H	17 IN (44 CM)
OVERALL WEIGHT	80 LB (36 KG)
SHIPPING WEIGHT	113 LB (51 KG)



OLYMPIC FLAT BENCH 9NN-B7503

W	61 IN (155 CM)
L	63 IN (160 CM)
H	54 IN (137 CM)
OVERALL WEIGHT	185 LB (84 KG)
SHIPPING WEIGHT	203 LB (92 KG)



**ADJUSTABLE ABDOMINAL DECLINE
BENCH 9NN-B7200**

W	25 IN (64 CM)
L	53 IN (135 CM)
H	34 IN (86 CM)
OVERALL WEIGHT	95 LB (43 KG)
SHIPPING WEIGHT	110 LB (50 KG)



**OLYMPIC INCLINE BENCH
9NN-B7201**

W	61 IN (155 CM)
L	63 IN (160 CM)
H	69 IN (175 CM)
OVERALL WEIGHT	269 LB (122 KG)
SHIPPING WEIGHT	291 LB (132 KG)



**DUMBBELL RACK 10-PAIR/3 TIER
9NN-R8002**

W	69 IN (175 CM)
L	29 IN (74 CM)
H	50 IN (127 CM)
OVERALL WEIGHT	243 LB (110 KG)
SHIPPING WEIGHT	267 LB (121 KG)



**DUMBBELL RACK 10-PAIR/2 TIER
9NN-R8001**

W	105 IN (267 CM)
L	29 IN (74 CM)
H	37 IN (94 CM)
OVERALL WEIGHT	221 LB (100 KG)
SHIPPING WEIGHT	251 LB (114 KG)



**45 DEGREE BACK EXTENSION
9NN-B7502**

W	32 IN (81 CM)
L	54 IN (137 CM)
H	39 IN (99 CM)
OVERALL WEIGHT	97 LB (44 KG)
SHIPPING WEIGHT	108 LB (49 KG)



**AB BENCH
9NN-B7505**

W	37 IN (94 CM)
L	61 IN (155 CM)
H	42 IN (106 CM)
OVERALL WEIGHT	148 LB (67 KG)
SHIPPING WEIGHT	172 LB (78 KG)



**MULTI-ADJUSTABLE BENCH
9NN-B7501**

W	27 IN (69 CM)
L	53 IN (135 CM)
H	18 IN (46 CM)
OVERALL WEIGHT	73 LB (33 KG)
SHIPPING WEIGHT	84 LB (50 KG)



DUAL ADJUSTABLE PULLEY 9NL-D2002

The Instinct Dual Adjustable Pulley features an integrated pull up bar with multi-grip hand positioning, steel shrouds that allow for customization and branding as well as rubber grip adjustment feet. The 2:1 lifting ratio has a smooth, low inertia operation and effective resistance of 100 LB (50 KG). The accessory rack hosts multiple pulley attachments which includes 2 stirrups grips, an ankle strap, a long bar and triceps/biceps curl bar. Plus, the DAP features our patented Lock N Load® weight selection system and a simple, intuitive workout placard.

WIDTH	36 IN (91 CM)
LENGTH	66 IN (168 CM)
HEIGHT	81 IN (207 CM)
STACK WEIGHT	2 X 400 LB (2 X 181 KG) 2 X 100 LB (AT HANDLE)
OVERALL WEIGHT	894 LB (406 KG)
SHIPPING WEIGHT	932 LB (423 KG)

HUMANSPORT

With a design inspired by the graceful, natural motions of the human body, HumanSport™ offers a truly unique and human way of conditioning. HumanSport is so simple, intuitive and natural that it feels as if it were custom-built for each and every user. Seven dual-function cable-based machines provide a complete range of workouts for total body training. When paired with the provided programming designed by our Master Trainers, HumanSport makes a powerful addition to any facility.





LOCK N LOAD® WEIGHT SELECTION SYSTEM

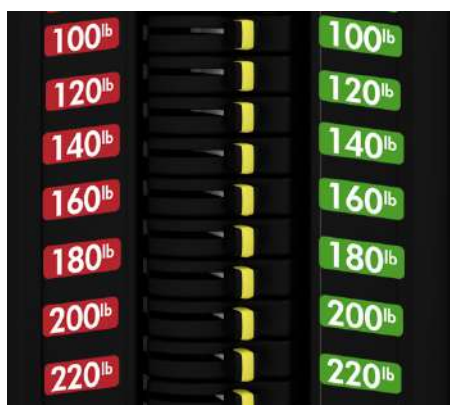

Nautilus selectorized strength has some of the most innovative and easy to use weight selection systems ever. Lock N Load® removes the need for pins, which can easily be lost or broken, meaning fewer maintenance headaches. Members will love the intuitive weight adjustment, which is as simple as flipping a switch.

DUAL WEIGHT STACK DESIGN

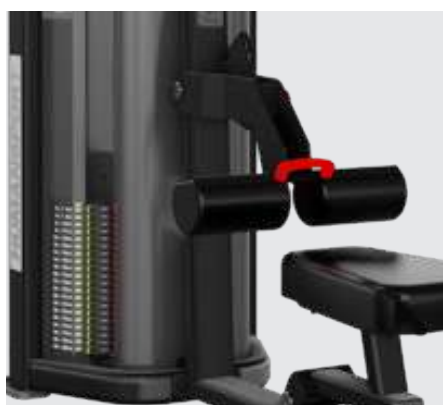

Designed with two weight stacks, HumanSport machines offer multiple training options for programs such as:

- Aerobics
- Back Strength
- Stay Young & Fit
- Tennis
- Golf
- Strength for Athletes
- Ski
- Running
- Soccer
- Cycling
- Climbing

HUMANSPORT FUNCTIONAL TRAINING



HumanSport is designed to allow unlimited resistance training options through movements in the seated isolated position, seated unstable position and standing position. By utilizing all three, your fitness staff can create any number of unique goal-based programs to cater to your desired client groups. These programs can be used for one-on-one personal training or to capitalize on small group training. Give your members an outstanding functional training tool and gain the ability to target all new client groups with HumanSport.



FREEDOM TRAINER HSFT3

W	75 IN (191 CM) Arms Extended Left and Right 125 IN (317 CM)
L	43 IN (108 CM)
H	72 IN (182 CM) Arms Extended Vertically Up 92 IN (234 CM)
STACK WEIGHT	2X 80 LB (2x 36 KG)
OVERALL WEIGHT	1,100 LB (499 KG)
SHIPPING WEIGHT	1,150 LB (522 KG)



ARM CRUNCH HSAC3

W	39 IN (99 CM)
L	43 IN (109 CM)
H	68 IN (172 CM)
STACK WEIGHT	2X 88 LB (2X 40 KG)
OVERALL WEIGHT	655 LB (298 KG)
SHIPPING WEIGHT	767 LB (348 KG)



TOTAL DETLS HSTD3

W	29 IN (74 CM)
L	78 IN (198 CM)
H	64 IN (163 CM)
STACK WEIGHT	2X 88 LB (2X 40 KG)
OVERALL WEIGHT	600 LB (273 KG)
SHIPPING WEIGHT	787 LB (357 KG)



WHEELCHAIR ACCESSIBLE

- 3:1 cable ratio for low starting resistance
- Open design allowing for wheelchair access
- Easily adjustable, counter balanced pivot handles, even while in the seated position
- Weight stack utilizes Lock N Load switch technology for quick and easy weight selection even while seated



WHEELCHAIR ACCESSIBLE

- 2:1 cable ratio for low starting resistance
- Flat anti-skid plate that can be used to roll in a wheelchair
- Adjustable stabilizer pad
- Seat is eliminated allowing for wheelchair access
- Accessory handles are optimally placed for easy access while in the seated position
- Weight stack utilizes Lock N Load switch technology for quick and easy weight selection even while seated



WHEELCHAIR ACCESSIBLE

- 2:1 cable ratio for low starting resistance
- Fold away seat to allow for wheelchair access
- Accessory handles are optimally placed for easy access while in the seated position
- Weight stack utilizes Lock N Load switch technology for quick and easy weight selection even while seated



LAT PULLEY HSLP3

W	58 in (147 cm)
L	58 in (147 cm)
H	83 in (211 cm)
STACK WEIGHT	2x 88 LB (2x 40 KG)
OVERALL WEIGHT	655 LB (298 KG)
SHIPPING WEIGHT	772 LB (351 KG)



SHOULDER CHEST HSSC3

W	63 in (160 cm)
L	45 in (114 cm)
H	64 in (163 cm)
STACK WEIGHT	2x 88 LB (2x 40 KG)
OVERALL WEIGHT	655 LB (298 KG)
SHIPPING WEIGHT	772 LB (351 KG)



PULL LIFT HSPL3

W	39 in (99 cm)
L	78 in (198 cm)
H	95 in (241 cm)
STACK WEIGHT	2x 88 LB (2x 40 KG)
OVERALL WEIGHT	750 LB (341 KG)
SHIPPING WEIGHT	850 LB (386 KG)



WHEELCHAIR ACCESSIBLE

- 2:1 cable ratio for low starting resistance
- Fold away seat to allow for wheelchair access
- Knee pad adjustment stabilizes users lifting heavy loads
- Accessory handles are optimally placed for easy access while in the seated position
- Weight stack utilizes Lock N Load switch technology for quick and easy weight selection even while seated



WHEELCHAIR ACCESSIBLE

- 2:1 cable ratio for low starting resistance
- Fold away seat to allow for wheelchair access
- Accessory handles are optimally placed for easy access while in the seated position
- Weight stack utilizes Lock N Load switch technology for quick and easy weight selection even while seated



TOTAL LEGS HSTL3

W	39 in (99 cm)
L	64 in (163 cm)
H	65 in (165 cm)
STACK WEIGHT	2x 88 LB (2x 40 KG)
OVERALL WEIGHT	691 LB (314 KG)
SHIPPING WEIGHT	772 LB (350 KG)



LEVERAGE

The Nautilus Leverage® line offers a one-of-a-kind plate loaded experience with features that outshine the competition. Leverage features stainless steel knurled grips, assisted seat adjustments and user pre-stretch settings. Using multiple levers and cams, Leverage creates a unique lifting profile for each movement that maximizes the mechanics of the human body. With a sleek look and integrated storage, the Leverage strength line will appeal to facility operators and their members. It's all about the feel and once you've exercised on Leverage, pushing and pulling weight plates will never be the same again.





A PERFECT PARTNERSHIP



Throwdown Free Weights pair perfectly with Nautilus Strength products allowing you to get everything in one place. You can even find free weight sets crafted specifically for popular Nautilus Benches & Racks, Leverage and Plate Loaded products.

ZERO SHORTCUTS ALL GAINS



Leverage is about the freedom to build, create and show off. Designed with low load points, one-of-a-kind lever and pivot points for optimum biomechanics and intuitive touch points and user-friendly gas shock assisted seat adjust.

PRODUCT CUSTOMIZATION



We know what it takes to build an authentic, meaningful brand experience. Our customization program is the perfect way to leverage your personal brand and make a strong first impression. Get Leverage machines in a variety of custom frame color and upholstery options.

[SEE PAGE 113 FOR MORE DETAILS](#)



LOW ROW 9NP-L3004

W	51 IN (130 CM)
L	79 IN (201 CM)
H	46 IN (117 CM)
STACK WEIGHT	N/A
OVERALL WEIGHT	426 LB (193 KG)
SHIPPING WEIGHT	567 LB (257 KG)



SHOULDER PRESS 9NP-L4002

W	51 IN (130 CM)
L	71 IN (180 CM)
H	58 IN (147 CM)
STACK WEIGHT	N/A
OVERALL WEIGHT	410 LB (186 KG)
SHIPPING WEIGHT	567 LB (257 KG)



CHEST PRESS 9NP-L2002

W	59 IN (150 CM)
L	71 IN (180 CM)
H	58 IN (147 CM)
STACK WEIGHT	N/A
OVERALL WEIGHT	481 LB (218 KG)
SHIPPING WEIGHT	622 LB (282 KG)



ABDOMINAL CRUNCH 9NP-L5003

W	61 IN (156 CM)
L	62 IN (157 CM)
H	61 IN (156 CM)
STACK WEIGHT	N/A
OVERALL WEIGHT	461 LB (209 KG)
SHIPPING WEIGHT	611 LB (277 KG)



INCLINE PRESS 9NP-L2003

W	51 IN (130 CM)
L	76 IN (193 CM)
H	51 IN (130 CM)
STACK WEIGHT	N/A
OVERALL WEIGHT	413 LB (187 KG)
SHIPPING WEIGHT	556 LB (252 KG)



LAT PULL DOWN 9NP-L3003

W	51 IN (130 CM)
L	81 IN (206 CM)
H	80 IN (203 CM)
STACK WEIGHT	N/A
OVERALL WEIGHT	406 LB (184 KG)
SHIPPING WEIGHT	541 LB (245 KG)



DECLINE PRESS 9NP-L2004

W	58 IN (147 CM)
L	81 IN (206 CM)
H	49 IN (124 CM)
STACK WEIGHT	N/A
OVERALL WEIGHT	503 LB (228 KG)
SHIPPING WEIGHT	670 LB (304 KG)



HIGH ROW 9NP-L3005

W	51 IN (130 CM)
L	86 IN (218 CM)
H	73 IN (185 CM)
STACK WEIGHT	N/A
OVERALL WEIGHT	443 LB (201 KG)
SHIPPING WEIGHT	582 LB (264 KG)



BICEPS CURL 9NP-L5002

W	62 IN (157 CM)
L	61 IN (155 CM)
H	41 IN (104 CM)
STACK WEIGHT	N/A
OVERALL WEIGHT	465 LB (211 KG)
SHIPPING WEIGHT	629 LB (285 KG)



FEATURES

- Stainless steel knurled grip
- Max capacity 270 LB (123 KG) per arm
- Starting resistance 25 LB (11 KG) per arm
- Unilateral and bilateral use
- Linear motion with user pre-stretch adjustment for optimal start position
- Spring loaded pop pins for pre-stretch adjustments and to lock out the left and rights for bilateral use
- Pivot points to create leverage
- Weight plates sold separately

DEADLIFT SHRUG NP-L3006

Working out with plates is one of the most effective ways to train, which is why plate loaded machines are a staple for facilities. Whether you are looking to build a full strength circuit or round out your offering with specific pieces, Nautilus Leverage® offers the best machines for plate workouts. Each machine is built strong enough to stand up to full commercial use and is designed to make plate workouts as effective, rewarding and safe as possible.

WIDTH	61 IN (156 CM)
LENGTH	74 IN (188 CM)
HEIGHT	31 IN (79 CM)
OVERALL WEIGHT	249 LB (113 KG)
SHIPPING WEIGHT	393 LB (178 KG)



PLATE LOADED

It's no secret that working out with plates is one of the most effective ways to train and condition, but it's what you do with those weights that makes all the difference. Designed to make working out with plates as effective, rewarding and safe as possible, our Plate Loaded line occupies its own unique place in training and on your facility floor. With industry standard designs like our Hack Squat, we helped set the benchmark for traditional plate loaded machines. When it comes to innovation we've led the way with our 7 degree angled Smith Machine and the Freedom Rack™, which delivers the safety of a Smith Machine and the versatility of a Power Rack.





A PERFECT PARTNERSHIP



Throwdown Free Weights pair perfectly with Nautilus Strength products allowing you to get everything in one place. You can even find free weight sets crafted specifically for popular Nautilus Benches & Racks, Leverage and Plate Loaded products.

TREND SETTING INNOVATION

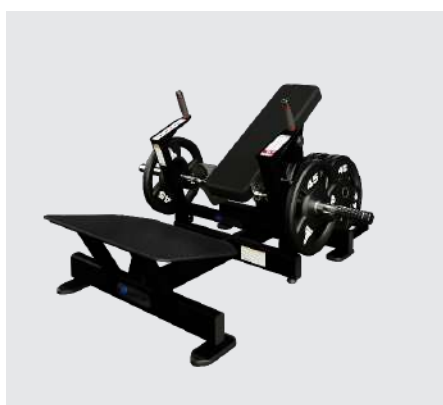

The Nautilus Glute Drive safely and smartly isolates your glutes, building power through a strong hip bridge motion, creating sexy glutes, improved hip and core stability. The Glute Drive gives you the full benefits of the hip thrust exercise, simply, safely, and with good form. A comfortable padded belt secures the user to the back pad which supports the full length of the spine for added safety. Users can load up to four plates on each side, which gives the machine a max weight load of 360 LB.

PRODUCT CUSTOMIZATION



We know what it takes to build an authentic, meaningful brand experience. Our customization program is the perfect way to leverage your personal brand and make a strong first impression. Get Plate Loaded machines in a variety of custom frame color and upholstery options.

[SEE PAGE 113 FOR MORE DETAILS](#)



GLUTE DRIVE NP-L1131

The Nautilus Glute Drive safely and smartly isolates your glutes, building power through a strong hip bridge motion, creating sexy glutes, improved hip and core stability. The Glute Drive gives you the full benefits of the hip thrust exercise, simply, safely, and with good form. A comfortable padded belt secures the user to the back pad which supports the full length of the spine for added safety. Users can load up to four plates on each side, which gives the machine a max weight load of 360 LB.

WIDTH	60 IN (152.5 CM)
LENGTH	62 IN (157.5 CM)
HEIGHT	35 IN (89 CM)
OVERALL WEIGHT	252 LB (114 KG)
SHIPPING WEIGHT	305 LB (138 KG)



ANGLED LEG PRESS NP-L1141

W	72 IN (182 CM)
L	90 IN (229 CM)
H	58 IN (147 CM)
STACK WEIGHT	N/A
OVERALL WEIGHT	569 LB (258 KG)
SHIPPING WEIGHT	651 LB (295 KG)



FREEDOM RACK® NP-L8507

W	75 IN (191 CM)
L	83 IN (211 CM)
H	90 IN (229 CM)
STACK WEIGHT	N/A
OVERALL WEIGHT	655 LB (297 KG)
SHIPPING WEIGHT	829 LB (376 KG)



HACK SQUAT NP-L1130

W	72 IN (182 CM)
L	93 IN (236 CM)
H	47 IN (119 CM)
STACK WEIGHT	N/A
OVERALL WEIGHT	446 LB (202 KG)
SHIPPING WEIGHT	604 LB (274 KG)



SMITH MACHINE NP-L8500

W	89 IN (226 CM)
L	67 IN (170 CM)
H	82 IN (208 CM)
STACK WEIGHT	N/A
OVERALL WEIGHT	648 LB (294 KG)
SHIPPING WEIGHT	794 LB (360 KG)



TILT SEAT CALF NP-L1110

W	27 IN (69 CM)
L	58 IN (147 CM)
H	37 IN (94 CM)
STACK WEIGHT	N/A
OVERALL WEIGHT	170 LB (77 KG)
SHIPPING WEIGHT	203 LB (92 KG)



INCLINE LEVER ROW NP-L3140

W	34 IN (86 CM)
L	72 IN (183 CM)
H	49 IN (124 CM)
STACK WEIGHT	N/A
OVERALL WEIGHT	214 LB (97 KG)
SHIPPING WEIGHT	252 LB (114 KG)



MULTI-STATIONS

Sometimes you have space for multiple pieces of equipment and sometimes you don't. That is exactly why our multi-stations are a great option when you're still looking for the total workout experience and commercial feel while needing to maximize space.

Each of our multi-stations have the smallest possible footprint, while combining the most essential elements from our strength lines. Add in great features like swiveling pulleys on the Lat Pull Down, Low Row and Triceps Press and fully adjustable pulleys on the Cable Crossover System, and you have an economical, space-saving equipment solution that doesn't look, feel or train like one.





CABLE CROSS OVER 9NP-M9201

W	158 IN (401 CM)
L	34 IN (86 CM)
H	91 IN (230 CM)
STACK WEIGHT	2 X 115.5 LB (2 X 52.2 KG)
OVERALL WEIGHT	1010 LB (458 KG)
SHIPPING WEIGHT	1025 LB (465 KG)



4 STATION 9NP-M9601

W	75 IN (190 CM)
L	152 IN (387 CM)
H	94 IN (239 CM)
STACK WEIGHT	LAT PULL DOWN/LOW ROW 297 LB (135 KG) TRICEPS PRESS 231 LB (105 KG) CROSS OVER 115.5 LB (52.5 KG)
OVERALL WEIGHT	1689 LB (766 KG)
SHIPPING WEIGHT	1916 LB (869 KG)

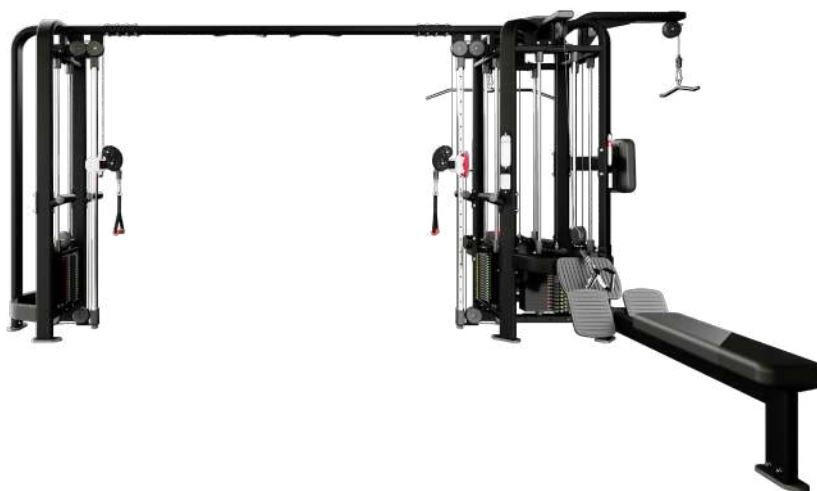

5 STATION 9NP-M9605

W	200 IN (508 CM)
L	152 IN (387 CM)
H	94 IN (239 CM)
STACK WEIGHT	LAT PULL DOWN/LOW ROW 297 LB (135 KG) TRICEPS PRESS 231 LB (105 KG) CROSS OVER 2 X 115.5 LB (2 X 52.5 KG)
OVERALL WEIGHT	2350 LB (1066 KG)
SHIPPING WEIGHT	2556 LB (1160 KG)



9 STATION 9NP-M9619

W	240 IN (609 CM)
L	152 IN (387 CM)
H	94 IN (239 CM)
STACK WEIGHT	LAT PULL DOWN/LOW ROW 297 LB (135 KG) TRICEPS PRESS 231 LB (105 KG) CROSS OVER 2 X 115.5 LB (2 X 52.5 KG)
OVERALL WEIGHT	3690 LB (1673 KG)
SHIPPING WEIGHT	3980 LB (1806 KG)



14 STATION 9NP-M9620

W	395 IN (1003 CM)
L	152 IN (387 CM)
H	94 IN (239 CM)
STACK WEIGHT	LAT PULL DOWN/LOW ROW 297 LB (135 KG) TRICEPS PRESS 231 LB (105 KG) CROSS OVER 2 X 115.5 LB (2 X 52.5 KG)
OVERALL WEIGHT	5565 LB (2524 KG)
SHIPPING WEIGHT	6010 LB (2726 KG)

NEW MID ROW

The Mid Row station is designed to target and strengthen the muscles of the middle back and shoulder areas. This machine offers adjustable resistance settings, swiveling pulley, which allows users to customize the intensity of their workout based on their fitness level and goals. A key advantage of a Mid Row station is its ability to isolate and target specific muscle groups, particularly the muscles of the middle back. This multi-station add in is an economical, space-saving equipment solution that doesn't look, feel or train like one.

FEATURES:

- Mid Row with swivel pulley
- Stabilization handles for balance and control
- Lock N Load® weight selection system
- Rubber feet for floor protection
- 5 lb incremental add on plates
- All steel adjustable pulleys with single hand adjustment design

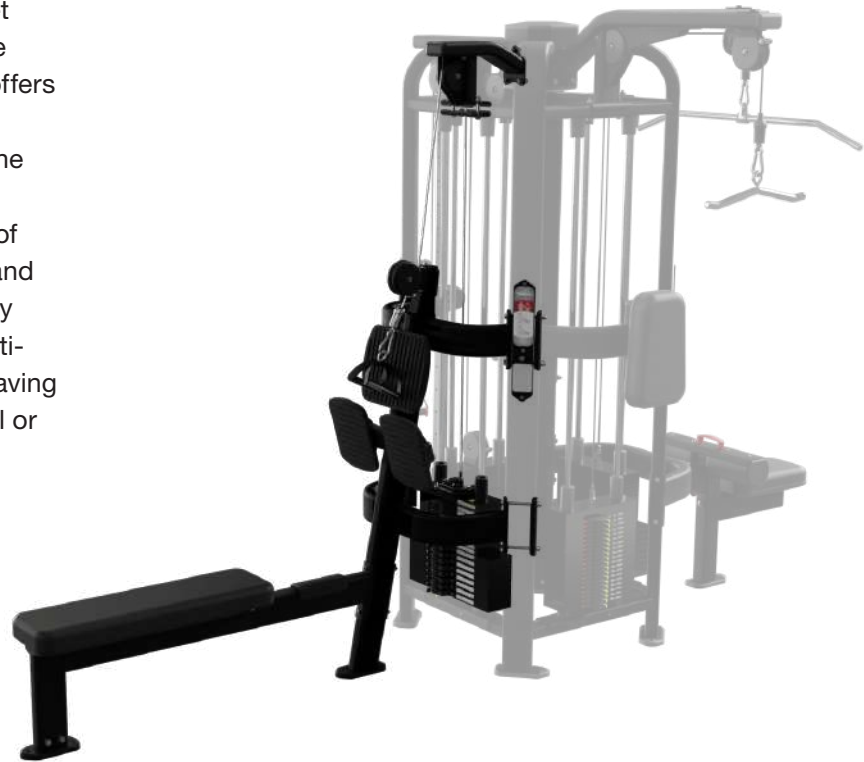

MID-ROW 731-9475

W	30 in (76 cm)
L	142 in (361cm)
H	94 in (239 cm)
STACK WEIGHT	297 lbs (135 kg)
OVERALL WEIGHT	162 lbs (90 kg)
SHIPPING WEIGHT (BOXED)	180 lbs (82 kg)
ASSISTED ADJUSTMENTS	N/A
GRIP SPECIFICATIONS	Stabilization handles for balance and control. Rubber, large grips for pushing, smaller grips for pulling.
FOOT PLATFORM	Independent rubber foot platforms for row stabilization
TOTAL STACK WEIGHT	297 lbs (135 kg)
CONVERGING OR DIVERGING MOVEMENTS	User defined path of motion with swivel pulley and unlimited high-low cable positioning combinations



BENCHES

From Olympic benches that can be customized with or without weight storage to our one-of-a-kind abdominal and back extension benches, we've raised the bar for both aesthetics and function. Our benches flow seamlessly with our other products so you will notice a family look and feel as you position your free weights along side our other strength lines. Our benches don't just look strong, they exceed industry requirements in all respects.





THOUGHTFUL DESIGN



Nautilus Benches have been designed not only for eye catching aesthetics but to also withstand the wear and tear of constant use. Featuring molded urethane bar holders for quiet and safe bar placement, benches with integrated grips and wheels for easy transport and all with rubber feet for floor protection.

A PERFECT PARTNERSHIP



Throwdown Free Weights pair perfectly with Nautilus Strength products allowing you to get everything in one place. You can even find free weight sets crafted specifically for popular Nautilus Benches & Racks, Leverage and Plate Loaded products.

PRODUCT CUSTOMIZATION



We know what it takes to build an authentic, meaningful brand experience. Our customization program is the perfect way to leverage your personal brand and make a strong first impression. Get Nautilus Benches with in a variety of custom frame color and upholstery options.

[SEE PAGE 113 FOR MORE DETAILS](#)



**MULTI-ADJUSTABLE BENCH
9NP-B7506**

W	27 IN (69 CM)
L	55 IN (140 CM)
H	16.5 IN (42 CM)
OVERALL WEIGHT	117 LB (53 KG)
SHIPPING WEIGHT	128 LB (58 KG)



MILITARY PRESS 9NP-B7205

W	74 IN (188 CM)
L	65 IN (165 CM)
H	60 IN (152 CM)
OVERALL WEIGHT	269 LB (122 KG)
SHIPPING WEIGHT	320 LB (145 KG)



**ADJUSTABLE INCLINE BENCH
9NP-B7523**

W	27 IN (69 CM)
L	56 IN (142 CM)
H	39 IN (99 CM)
OVERALL WEIGHT	113 LB (51 KG)
SHIPPING WEIGHT	143 LB (65 KG)



FLAT BENCH 9NP-B7507

W	27 IN (69 CM)
L	55 IN (140 CM)
H	20 IN (51 CM)
OVERALL WEIGHT	77 LB (35 KG)
SHIPPING WEIGHT	86 LB (39 KG)



UTILITY BENCH 9NP-B7516

W	27 IN (69 CM)
L	34 IN (86 CM)
H	38 IN (97 CM)
OVERALL WEIGHT	71 LB (32 KG)
SHIPPING WEIGHT	79 LB (36 KG)



**ADJUSTABLE DECLINE BENCH
9NP-B7508**

W	34 IN (86 CM)
L	53 IN (135 CM)
H	31 IN (79 CM)
OVERALL WEIGHT	155 LB (70 KG)
SHIPPING WEIGHT	181 LB (82 KG)



STOOL 9NP-B7521

W	31 IN (79 CM)
L	27 IN (68 CM)
H	17 IN (44 CM)
OVERALL WEIGHT	27 LB (12 KG)
SHIPPING WEIGHT	38 LB (17 KG)



**ADJUSTABLE BACK EXTENSION
9NP-B7514**

W	34 IN (86 CM)
L	53 IN (135 CM)
H	31 IN (79 CM)
OVERALL WEIGHT	157 LB (71 KG)
SHIPPING WEIGHT	190 LB (86 KG)



DECLINE BENCH PRESS 9NP-B7204

W	50 IN (127 CM)
L	70 IN (178 CM)
H	49 IN (124 CM)
OVERALL WEIGHT	177 LB (80 KG)
SHIPPING WEIGHT	199 LB (90 KG)



INCLINE BENCH PRESS 9NP-B7203

W	51 IN (130 CM)
L	59 IN (150 CM)
H	59 IN (150 CM)
OVERALL WEIGHT	185 LB (84 KG)
SHIPPING WEIGHT	210 LB (95 KG)



LEG RAISE/DIP 9NP-B7517

W	28 IN (71 CM)
L	61 IN (155 CM)
H	66 IN (168 CM)
OVERALL WEIGHT	267 LB (121 KG)
SHIPPING WEIGHT	311 LB (141 KG)



OLYMPIC BENCH PRESS 9NP-B7202

W	65 IN (165 CM)
L	73 IN (185 CM)
H	49 IN (124 CM)
OVERALL WEIGHT	115 LB (52 KG)
SHIPPING WEIGHT	139 LB (63 KG)



PULL-UP/DIP/LEG RAISE 9NP-B7511

W	48 IN (122 CM)
L	61 IN (155 CM)
H	90 IN (229 CM)
OVERALL WEIGHT	335 LB (152 KG)
SHIPPING WEIGHT	370 LB (168 KG)



DIP STATION 9NP-B7518

W	29 IN (114 CM)
L	45 IN (114 CM)
H	48 IN (122 CM)
OVERALL WEIGHT	148 LB (67 KG)
SHIPPING WEIGHT	179 LB (81 KG)



PREACHER CURL 9NP-B7509

W	30 IN (76 CM)
L	43 IN (109 CM)
H	40 IN (102 CM)
OVERALL WEIGHT	163 LB (74 KG)
SHIPPING WEIGHT	181 LB (82 KG)



STANDING PREACHER CURL 9NP-B7515

W	30 IN (76 CM)
L	39 IN (99 CM)
H	45 IN (114 CM)
OVERALL WEIGHT	174 LB (79 KG)
SHIPPING WEIGHT	190 LB (86 KG)



ADJUSTABLE ABDOMINAL BENCH 9NP-B7510

W	35 IN (89 CM)
L	55 IN (140 CM)
H	45 IN (114 CM)
OVERALL WEIGHT	159 LB (72 KG)
SHIPPING WEIGHT	176 LB (80 KG)



GLUTE HAM 9NP-B7522

W	43 IN (110 CM)
L	72 IN (182 CM)
H	48 IN (122 CM)
OVERALL WEIGHT	188 LB (85 KG)
SHIPPING WEIGHT	223 LB (101 KG)



STRETCH BENCH

Stretching is a vital step in the warm up or cool down of every workout. The Nautilus Stretch Bench helps members prepare themselves for a strong and productive workout. It helps prevent injury and leaves the user feeling flexible and ready pre and post workout. The Stretch Bench is lightweight, with a small footprint, ideal for any space in your facility. Plus, our benches and racks don't just look strong, they exceed industry requirements in all respects.

PRODUCT DIMENSIONS	
WIDTH	28 IN (71 CM)
LENGTH	52 IN (132 CM)
HEIGHT	36 IN (91 CM)
OVERALL WEIGHT	60 LB (27 KG)
SHIPPING WEIGHT	80 LB (36 KG)



FEATURES

- Placard provides step by step body position and hand placement
- Foot pedals for stability
- Integrated rubber grips for multiple hand positions and supports both single & dual hand stretches
- Padded-woven strap handles
- Floor protection and leveling feet standard
- Optional bolt-down kit included



RACKS

From racks that can be customized with or without weight storage to our revolutionary SVA Platforms, we've raised the bar for both form and function. Our racks flow seamlessly with our other products so you will notice a family look and feel as you position your free weights along side our other strength lines. Our racks don't just look strong, they exceed industry requirements in all respects.





THOUGHTFUL DESIGN



Nautilus Benches have been designed not only for eye catching aesthetics but to also withstand the wear and tear of constant use. Featuring mold-ed urethane bar holders for quiet and safe bar placement, benches with integrated grips and wheels for easy transport and all with rubber feet for floor protection.

OUT PERFORMING THE COMPETITION



The new Nautilus damping platform featuring a sustainable bamboo floor was developed as a way to reduce sound and vibration caused when users drop barbells when performing Olympic and power lifting. It uses a proprietary blend of materials designed to absorb the force of the barbell. These absorption characteristics not only cut down on sound and vibration, they also reduce bar bounce.

PRODUCT CUSTOMIZATION



We know what it takes to build an authentic, meaningful brand experience. Our customization program is the perfect way to leverage your personal brand and make a strong first impression. Get Nautilus platforms and racks with in a variety of custom frame color and branding options.

[SEE PAGE 113 FOR MORE DETAILS](#)

 <p>SUSTAINABILITY</p>	<p>Bamboo is a highly sustainable crop which requires no fertilizer, pesticides or chemicals. It's natural cultivation does not harm the environment. Bamboo is extremely strong while remaining a light weight building material.</p>
---	--

NEW

OUT PERFORMING THE COMPETITION

The new Nautilus dampening platform featuring a sustainable bamboo floor was developed as a way to reduce sound and vibration caused when users drop barbells when performing Olympic and power lifting. It uses a proprietary blend of materials designed to absorb the force of the barbell. These absorption characteristics not only cut down on sound and vibration, they also reduce bar bounce.

6' SVA PLATFORM



SVA PLATFORM BAMBOO II 9-HDP6D-BB2

WIDTH	95 in (241 cm)
LENGTH	141 in (358 cm)
HEIGHT	4 in (10 cm)
OVERALL WEIGHT	943 LB (428 KG)
SHIPPING WEIGHT (BOXED)	989 LB (449 KG)





SUSTAINABILITY

Bamboo is a highly sustainable crop which requires no fertilizer, pesticides or chemicals. It's natural cultivation does not harm the environment. Bamboo is extremely strong while remaining a light weight building material.

**Platform shown with Half Rack HDHR2*



**STAND ALONE SVA PLATFORM
BAMBOO II 9-HDP6D-BB2-SA**

WIDTH	95 in (241 cm)
LENGTH	77 in (196 cm)
HEIGHT	4 in (10 cm)
OVERALL WEIGHT	642 LB (292 KG)
SHIPPING WEIGHT	716 LB (325 KG)

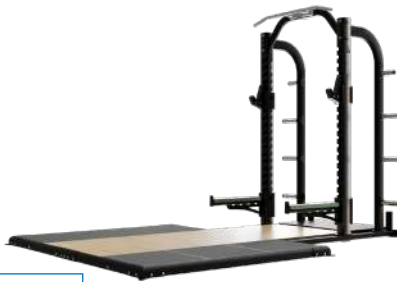

**Platform shown with Half Rack HDHR2*

**6' NAUTILUS BAMBOO PLATFORM II
9-HDP6-BB2**

WIDTH	95 in (241 cm)
LENGTH	141 in (358 cm)
HEIGHT	3 in (8 cm)
OVERALL WEIGHT	751 LB (341 KG)
SHIPPING WEIGHT	884 LB (401 KG)



**Platform shown with Half Rack HDHR2*

**4' NAUTILUS BAMBOO PLATFORM II
9-HDP4-BB2**

WIDTH	95 in (241 cm)
LENGTH	115 in (292 cm)
HEIGHT	3 in (8 cm)
OVERALL WEIGHT	655 LB (297 KG)
SHIPPING WEIGHT	690 LB (313KG)



**NAUTILUS 4' BAMBOO SVA
PLATFORM 9-HDP4-BB2**

WIDTH	95 in (241 cm)
LENGTH	53 in (135 cm)
HEIGHT	4 in (10 cm)
OVERALL WEIGHT	408 LB (185 KG)
SHIPPING WEIGHT	437 LB (198 KG)



**Platform shown with Half Rack HDHR2*

**4' BAMBOO SVA WITH HALF RACK
9-HDP4D-BB2-SA**

WIDTH	95 in (241 cm)
LENGTH	117 in (297 cm)
HEIGHT	4 in (10 cm)
OVERALL WEIGHT	589 LB (267 KG)
SHIPPING WEIGHT	620 LB (281KG)



**POWER CAGE SVA COMBO 9NP-R8006,
9-HDP6D-BB2, 731-9082-KT, 731-9092-KT**

WIDTH	95 in (241 cm)
LENGTH	143 in (363 cm)
HEIGHT	89 in (226 cm)
OVERALL WEIGHT	1276 LB (579 KG)
SHIPPING WEIGHT	1576 LB (715 KG)



**Platform shown with Life Fitness HD Elite Half Rack*

**HD SVA PLATFORM 6', LF HALF RACK
9-HDP6D-LFHR**

WIDTH	95 in (241 cm)
LENGTH	115 in (292 cm)
HEIGHT	4 in (10 cm)
OVERALL WEIGHT	751 LB (341 KG)
SHIPPING WEIGHT	825 LB (375 KG)



**HALF RACK
HDHR2**

WIDTH	72 in (183 cm)
LENGTH	63 in (160 cm)
HEIGHT	97 in (246 cm)
OVERALL WEIGHT	512 LB (232 KG)
SHIPPING WEIGHT	560 LB (254 KG)



SQUAT RACK NP-R8008

WIDTH	80 in (203 cm)
LENGTH	71 in (180 cm)
HEIGHT	79 in (201 cm)
OVERALL WEIGHT	445 LB (202 KG)
SHIPPING WEIGHT	476 LB (216 KG)



POWER CAGE
NP-R8006

WIDTH	63 in (160 cm)
LENGTH	69 in (174 cm)
HEIGHT	94 in (239 cm)
OVERALL WEIGHT	538 LB (244 KG)
SHIPPING WEIGHT	708 LB (321 KG)



BARBELL RACK
NP-R8012

WIDTH	36 in (91 cm)
LENGTH	38 in (97 cm)
HEIGHT	53 in (135 cm)
OVERALL WEIGHT	159 LB (72 KG)
SHIPPING WEIGHT	179 LB (81 KG)



ACCESSORY RACK
NP-R8013

WIDTH	28 in (71 cm)
LENGTH	35 in (89 cm)
HEIGHT	51 in (130 cm)
OVERALL WEIGHT	141 LB (64 KG)
SHIPPING WEIGHT	161 LB (73 KG)



2-SIDED OLYMPIC WEIGHT TREE
NP-R7512

WIDTH	27 in (69 cm)
LENGTH	35 in (89 cm)
HEIGHT	40 in (102 cm)
OVERALL WEIGHT	86 LB (39 KG)
SHIPPING WEIGHT	99 LB (45 KG)



4-SIDED OLYMPIC WEIGHT TREE
NP-R7513

WIDTH	28 in (71 cm)
LENGTH	28 in (71 cm)
HEIGHT	46 in (117 cm)
OVERALL WEIGHT	135 LB (61 KG)
SHIPPING WEIGHT	161 LB (73 KG)



BEAUTY BELL RACK
NP-R8014

WIDTH	32 in (81 cm)
LENGTH	40 in (102 cm)
HEIGHT	40 in (102 cm)
OVERALL WEIGHT	132 LB (60 KG)
SHIPPING WEIGHT	141 LB (64 KG)



SINGLE DUMBBELL RACK
NP-R8009

WIDTH	90 in (229 cm)
LENGTH	28 in (71 cm)
HEIGHT	26 in (66 cm)
OVERALL WEIGHT	155 LB (70 KG)
SHIPPING WEIGHT	181 LB (82 KG)

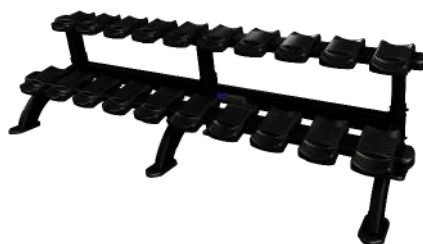

DOUBLE DUMBBELL RACK
NP-R8010

WIDTH	90 in (229 cm)
LENGTH	38 in (97 cm)
HEIGHT	26 in (66 cm)
OVERALL WEIGHT	255 LB (116 KG)
SHIPPING WEIGHT	285 LB (130 KG)



TRIPLE DUMBBELL RACK
NP-R8011

WIDTH	90 in (229 cm)
LENGTH	38 in (97 cm)
HEIGHT	39 in (99 cm)
OVERALL WEIGHT	387 LB (176 KG)
SHIPPING WEIGHT	409 LB (186 KG)



MAKE A STRONGER IMPRESSION

Brand is everything. And now, you can make an even longer lasting impression with customized strength equipment in your facility. With custom colored frames, upholstery and even your logo (on select equipment) you can enhance your brand. Put your best foot forward with Nautilus custom strength equipment.

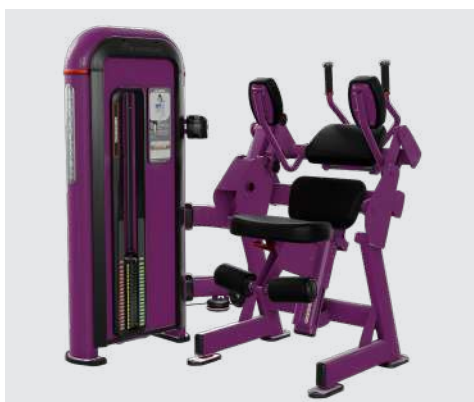



Rooted in cardio, Star Trac has grown to innovate products that keep people moving and create lifelong health and fitness habits. As we focus on intuitive designs and reliability, we go the distance to provide fitness solutions for the best workout experiences. With dynamic technology and OpenHub connectivity, Star Trac offerings compliment all fitness programs.

SECTION 5



MADE TO PERFORM

WHAT WE'RE KNOWN FOR

The brand used by enthusiasts

Great for tracking

Makes products that are fun to use

A reputable, trustworthy company





STAR TRAC®
MADE TO PERFORM

10 SERIES





BUILT WITH:
 **HexDeck**
 Technology



CONSOLES AND PVS



PVS



LCD



20" EMBEDDED

E G Y M
 5 STAR INTEGRATED

FreeRunner™ 10TRx

- Revolutionary new patented HexDeck technology features an aluminum running deck, supported by a proprietary, hexagonal polymer suspension system that creates a treadmill with unprecedented cushion and responsiveness
- 20% max incline | 15 mph (24 kmh) max speed
- Star Trac's popular personal fan for comfort
- Integrated USB port provides charging capability for user devices
- User weight capacity of 500 lb (227 KG)
- Contact and telemetry heart rate
- 11" (27.9 cm) step-up height



Overall Weight
 494 lb (224 KG)

Width
 35" (88 cm)

Length
 81" (207 cm)

Height
 60" (160 cm)

Running Surface
 60" x 22"
 (152 x 55 cm)



STAR TRAC
MADE TO PERFORM

8 SERIES





BUILT FOR QUALITY AND PERFORMANCE

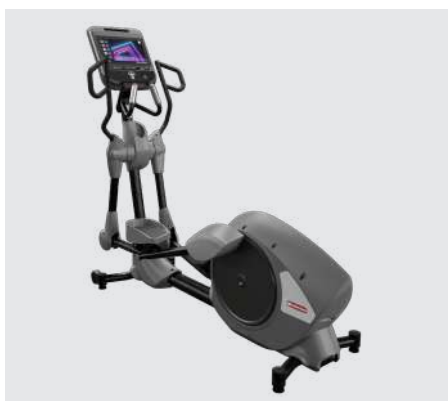

The Star Trac 8 Series line was built to give you the quality and performance you expect from high-end machines with user focused features like dual personal fans, a hot bar with heart rate monitoring and Soft Trac® technology. For a premium experience pair any 8 Series machine with the OpenHub console which provides entertainment, fitness tracking and asset management solutions that will offer a complete fitness experience to facility owners and their members.

MANAGEMENT SOLUTIONS



ECOFIT® asset management solutions let you see beyond the basics of which machines are most used – you'll get insights that show you if you should rotate machine placements to improve maintenance scheduling, identify and plan preventative maintenance to ensure equipment is available to members and much more.

[SEE PAGE 145 FOR MORE PARTNER SOLUTIONS](#)

OPENHUB™ CONSOLE



The 16/20" Capacitive Touch OpenHub Console offers a premium user interface design, Star Trac 20 HIIT Programming, RunTV, tap to pair technology (Apple Watch + Samsung Watch) and integrated apps for streaming entertainment, news, and workout motivation. With standard features like HDMI streaming, Bluetooth connectivity and TV tuner accessories, this is a display that has something for every user.

[SEE PAGES 140-145 FOR MORE CONSOLE DETAILS](#)

Treadmill 8TRx

- Soft Trac® triple cell cushioning system provides maximum shock absorption making the entire deck a sweet spot
- 20% max incline | 15 mph (24 kmh) max speed
- Star Trac's popular personal fan for comfort
- Integrated USB port provides charging capability for user devices
- User weight capacity of 500 lb (227 KG)
- Contact and telemetry heart rate
- 11" (28 cm) step-up height



Overall Weight
388 lb (176 KG)

Width
36" (91 cm)

Length
85" (215 cm)

Height
63" (152 cm)

Running Surface
60" x 22"
(152 x 55 cm)

Treadmill 8TR

- Soft Trac® triple cell cushioning system provides maximum shock absorption
- 15% max incline | 12.5 mph (20 kmh) max speed
- Star Trac's popular personal fan for comfort
- Integrated USB port provides charging capability for user devices
- User weight capacity of 500 lb (227 KG)
- Contact and telemetry heart rate
- 10" (25 cm) step-up height



Overall Weight
425 lb (193 KG)

Width
32" (81 cm)

Length
81" (206 cm)

Height
63" (160 cm)

Running Surface
60" x 22"
(152 x 55 cm)

VersaStrider™ 8VS

- MyStride™ technology in the VersaStrider allows users to vary stride length dynamically - no buttons to push, just stride
- Level control buttons are integrated into movement arms - adjust level without letting go of handles
- Integrated movement wheel at rear of machine allows one person to easily maneuver the unit for placement or service
- Movement arms follow a converging path of motion that closely follows the human body's natural movement
- 10" - 32" (25 - 81 cm) stride length
- Star Trac's popular personal fan for comfort
- Integrated USB port provides charging capability for user devices
- User weight capacity 400 lb (181 KG)
- Contact and telemetry heart rate



Overall Weight
586 lb (266 KG)

Width
35" (89 cm)

Length
89" (226 cm)

Height
69" (175 cm)

Cross Trainer 8CT

- Efficient footprint and approachable, stable platform with minimal step-up height for easy access from all angles
- Soft Trac® pedals provide ultimate shock-absorbing comfort throughout the entire workout
- 18" (47 cm) stride length
- Star Trac's popular personal fan for comfort
- Integrated USB port provides charging capability for user devices
- User weight capacity 400 LB (181KG)
- Contact and telemetry heart rate



Overall Weight
337 lb (153 KG)

Width
30" (76 cm)

Length
76" (193 cm)

Height
72" (182 cm)

Rear Drive Elliptical 8RDE

- Ergonomic hand grips offer multiple hand positions and heart rate detection
- Articulating foot pads create a very comfortable and natural stride pattern
- Soft Trac® pedals provide ultimate shock-absorbing comfort throughout the entire workout
- 18" (47 cm) stride length
- Star Trac's popular personal fan for comfort
- Integrated USB port provides charging capability for user devices
- User weight capacity 400 LB (181KG)
- Contact and telemetry heart rate



Overall Weight
400 LB (181KG)

Width
36" (91 cm)

Length
86" (218.44 cm)

Height
73" (185 in)

Upright Bike 8UB

- Dual platform pedals with ratcheting straps provide user with option for secure hold or strap-free platform workout
- Easy-up seat adjust for simple seat position changes
- Morse Taper bottom bracket and pedal system for extreme durability
- Star Trac's popular personal fan for comfort
- Integrated USB port provides charging capability for user devices
- User weight capacity 350 lb (159 KG)
- Contact and telemetry heart rate



Overall Weight
141 lb (64 KG)

Width
23" (58 cm)

Length
46" (117 cm)

Height
63" (160 cm)

Recumbent Bike 8RB

- Dual platform pedals with ratcheting straps provide user with option for secure hold or strap-free platform workout
- Contoured backrest for increased airflow and comfort
- Armrests alleviate tension in the shoulders and allow for a more relaxed posture
- Morse Taper bottom bracket and pedal system for extreme durability
- Star Trac's popular personal fan for comfort
- Integrated USB port provides charging capability for user devices
- User weight capacity 350 lb (159 KG)
- Contact and telemetry heart rate



Overall Weight
185 lb (84 KG)

Width
28" (71 cm)

Length
65" (164 cm)

Height
60" (151 cm)

CONSOLES AND PVS



PVS



LCD



20" EMBEDDED



8TR LCD



LCD



16" EMBEDDED

E G Y M
5 STAR INTEGRATED

Virtual Bike

The Star Trac Virtual Bike combines the state-of-the-art commercial grade group cycle built by Schwinn with a 21" touchscreen display to create the ultimate cycling workout experience.

The Virtual Bike is purpose-built to withstand the rigors of a commercial cardio floor and meet the needs of non-staffed vertical market spaces such as hospitality and multi-housing.



CONTENT

We have partnered with Intelligent Cycling to provide a wide range of training options and content including:

- Instructor-led rides
- Scenic journeys
- Virtual worlds
- Includes professionally designed training programs.
- Content will be regularly added to and refreshed.
- Connect via WiFi or ethernet
- No subscription required

POWER REQUIRED

OTHER KEY FEATURES

- Automatic software updates and upgrades! New content, partners, and features will be added as they are integrated into the offering.
- Tap to pair with Apple GymKit and Samsung Galaxy Watch.
- Users can create login to save personal profile and workout data.
- Ability to access Apps including Netflix.
- Connect cycling Apps such as Zwift, Sufferfest, Rouvy, and Trainer Road.
- HDMI screen mirroring – see your connected App on the big screen!

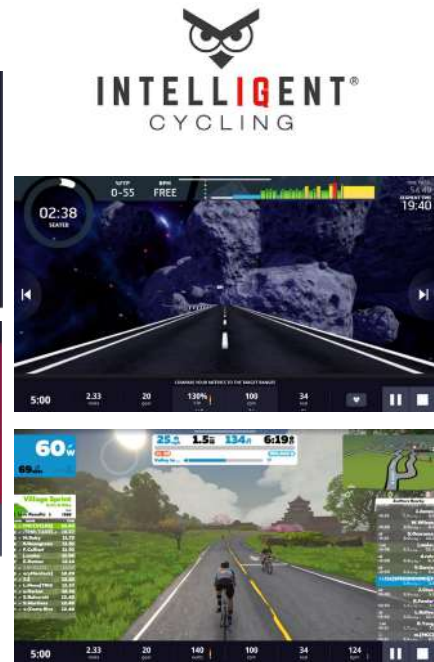
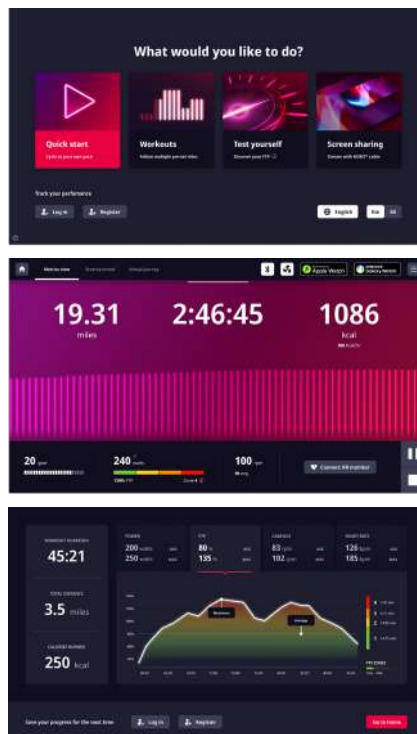



VIRTUAL BIKE

CONSOLE	
DISPLAY	21" Touchscreen
WORKOUT CONTENT & PARTNERS	Instructor-led rides, scenic rides, HIIT based workouts, FTP Fitness test, and Intelligent Cycling® signature THE JOURNEY which takes the user through virtual cycling adventures in 3D worlds.
ENTERTAINMENT APPS	Netflix, YouTube, Facebook, Instagram, Reddit, NPR, Weather Channel and more
LANGUAGES	English, Italian, Finnish, Czech, Slovak, Japanese, Chinese (Simplified & Traditional), Russian, Hebrew, Danish, English - UK, Dutch, Spanish, French, Portuguese, German, Swedish, Polish, Turkish, Korean, Modern Standard Arabic
FAN	Yes
WIFI / ETHERNET	Yes
BLUETOOTH & ANT+	Yes
APPLE GYMKIT AND SAMSUNG GALAXY WATCH	Yes, Tap to Pair
USB PORT	Yes
FRAME	
POWER MANAGEMENT	4iiii Power Meter direct power measurement
RESISTANCE SYSTEM	6 Magnet, Non-Contact Magnetic Resistance
DRIVE SYSTEM / DRIVE TRAIN	Smooth Poly V
PEDALS	Morse Taper Double Link - SPD and Athletic Shoe Cage
Q FACTOR	168 mm
SADDLE DESIGN	Ergonomically Sculpted Saddle
ADJUSTABILITY	Seat: Fore / Aft & Up / Down, Handlebars: Fore / Aft & Up / Down
SEAT ADJUSTMENT	Pop-pin
FORE / AFT ADJUSTMENT SYSTEM	Level Micro Adjustment
WATER BOTTLE HOLDER / ACCESSORIES HOLDER	Yes
CUSTOMIZABLE	Paint color options approval required
FRAME MATERIAL & FINISH	Aluminum, Powder-coated
FRAME COLOR	Quantum Silver
ASSEMBLED DIMENSIONS L x W x H	53in x 21in x 62in (135 x 53 x 158 cm)
POWER REQUIREMENT	100-240 V - 50/60 Hz Ac
USER HEIGHT RANGE	4'11 to 6'8 (150cm - 203cm)
MAX USER WEIGHT	350lb (159kg)
PRODUCT WEIGHT	176 lbs (80 kg)
SHIPPING DIMENSIONS	44.5 in x 10.6 in x 38 in (113 cm x 27 cm x 97 cm)
SHIPPING WEIGHT	152 LBS (69 KG)
ADDITIONAL SKUS	

9-7555-8VB-79QS
700-0504-XX (Optional Dumbbell Holder Attachment)

4 SERIES





COMPLETE LINE OF CARDIO EQUIPMENT



The 4 Series cardio line from Star Trac is the perfect solution for the hospitality and multi family housing markets. With premium full color flat panel displays, quick select adjustment keys, and optional personal viewing screen, the 4 Series provides smaller facilities with the look and performance of a full commercial product.

MANAGEMENT SOLUTIONS



ECOFIT® asset management solutions let you see beyond the basics of which machines are most used – you'll get insights that show you if you should rotate machine placements to improve maintenance scheduling, identify and plan preventative maintenance to ensure equipment is available to members and much more.

[SEE PAGE 137 FOR MORE PARTNER SOLUTIONS](#)

CONSOLES FOR EVERY BUDGET



The 4 Series cardio line of products offer three console options; 4 Series 15" Capacitive Touch, 4 Series 10" Touch or 4 Series 10". With so many options you're sure to find the right solution for your space.

[SEE PAGES 132-137 FOR MORE CONSOLE DETAILS](#)

Treadmill 4TR

- 15% max incline | 12.5 mph (20 kmh) max speed
- Choose between 4 Series 15" Embedded, 10" Touchscreen or 10" LCD versions of the new OpenHub™ family of consoles
- Star Trac's popular personal fan for comfort
- Integrated USB port provides charging capability for user devices
- User weight capacity of 450 lb (205 KG)
- Contact and telemetry heart rate
- 7" (17.7 cm) step-up height



Overall Weight
399 lb (181 KG)

Width
32 in (81 cm)

Length
81" (206 cm)

Height
60 in (152 cm)

Running Surface
60" x 22"
(152 cm x 55 cm)

Cross Trainer 4CT

- Efficient footprint and approachable, stable platform with minimal step-up height for easy access from all angles
- Soft Trac® pedals provide ultimate shock-absorbing comfort throughout the entire workout
- 20" (51 cm) stride length
- Choose between 4 Series 15" Embedded, 10" Touchscreen or 10" LCD versions of the new OpenHub™ family of consoles
- Star Trac's popular personal fan for comfort
- Integrated USB port provides charging capability for user devices
- User weight capacity 450 LB (204 KG)
- Contact and telemetry heart rate



Overall Weight
273 lb (124 KG)

Width
30 in (76 cm)

Length
76 in (193 cm)

Height
72 in (183 cm)

Recumbent Bike 4RB

- Walk-through design and intuitive wrap-around seat adjust allow users to access and change seat position with ease
- Choose between 4 Series 15" Embedded, 10" Touchscreen or 10" LCD versions of the new OpenHub™ family of consoles
- Star Trac's popular personal fan for comfort
- Integrated USB port provides charging capability for user devices
- User weight capacity 450 LB (204 KG)
- Contact and telemetry heart rate



Overall Weight
186 lb (84 KG)

Width
23" (59 cm)

Length
68" (172 cm)

Height
54" (137 cm)

Upright Bike 4UB

- Choose between 4 Series 15" Embedded, 10" Touchscreen or 10" LCD versions of the new OpenHub™ family of consoles
- Star Trac's popular personal fan for comfort
- Integrated USB port provides charging capability for user devices
- User weight capacity 450 LB (204 KG)
- Contact and telemetry heart rate



Overall Weight
132 lb (60 KG)

Width
23" (58 cm)

Length
46" (117 cm)

Height
57" (145 cm)

CONSOLES AND PVS



PVS



LCD



**10" TOUCH
SCREEN**



EMBEDDED



S SERIES





BEAUTIFUL DESIGN EXCEPTIONAL VALUE



Featuring all of Star Trac's popular user-focused features like adjustable personal fans, easy-up and wrap-around seat adjusts and dual-platform pedals, the S Series gives you many of the features you'd never expect to find for the price. And then it goes beyond with components like our large LED display with oversized buttons and text, providing the easiest and most intuitive operation available.

PERSONAL VIEWING SCREEN (PVS)



All of our S-Series cardio products are pre-wired to accept an add-on 15.6" HD Personal Viewing Screen. The PVS mounts seamlessly to the product, and an integrated control keypad inserts into the front of the cardio display for easy control.

MANAGEMENT SOLUTIONS



ECOFIT® asset management solutions let you see beyond the basics of which machines are most used – you'll get insights that show you if you should rotate machine placements to improve maintenance scheduling, identify and plan preventative maintenance to ensure equipment is available to members and much more.

[SEE PAGE 137 FOR MORE PARTNER SOLUTIONS](#)

Treadmill STRc

- Soft Trac® triple cell cushioning system provides maximum shock absorption making the entire deck a sweet spot
- 15% max incline | 12.5 mph (20 kmh) max speed
- Star Trac's popular personal fan for comfort
- User weight capacity of 500 lb (227 KG)
- Contact and telemetry heart rate
- 7" (17.7 cm) step-up height



Overall Weight
381 lb (173 KG)

Width
32" (81 cm)

Length
81" (206 cm)

Height
58" (147 cm)

Running Surface
60" x 22"
(152 cm x 55 cm)

Treadmill STRx

- Soft Trac® triple cell cushioning system provides maximum shock absorption making the entire deck a sweet spot
- 15% max incline | 12.5 mph (20 kmh) max speed
- Star Trac's popular personal fan for comfort
- User weight capacity 350 lb (159 KG)
- Contact and telemetry heart rate
- 7" (17.7 cm) step-up height



Overall Weight
370 lb (168 KG)

Width
32" (81 cm)

Length
81" (206 cm)

Height
55" (140 cm)

Running Surface
60" x 22"
(152 x 55 cm)

Cross Trainer SCTx

- Efficient footprint and approachable, stable platform with minimal step-up height for easy access from all angles
- 18" (47 cm) stride length
- Star Trac's popular personal fan for comfort
- User weight capacity 350 lb (159 KG)
- Contact and telemetry heart rate



Overall Weight
337 lb (153 KG)

Width
30" (76 cm)

Length
76" (193 cm)

Height
72" (183 cm)

Upright Bike SUBx

- Dual platform pedals with ratcheting straps provide user with option for secure hold or strap-free platform workout
- Easy-up seat adjust for simple seat position changes
- Morse Taper bottom bracket and pedal system
- Star Trac's popular personal fan for comfort
- User weight capacity 350 lb (159 KG)
- Contact and telemetry heart rate



Overall Weight
141 lb (64 KG)

Width
23" (58 cm)

Length
46" (117 cm)

Height
57" (145 cm)

Recumbent Bike SRBx

- Walk-through design and intuitive wrap-around seat adjust allow users to access and change seat position with ease
- Dual platform pedals with ratcheting straps provide user with option for secure hold or strap-free platform workout
- Armrests alleviate tension in the shoulders and allow for a more relaxed posture
- Wrap-around seat adjust provides an intuitive handle for simple seat position changes
- Morse Taper bottom bracket and pedal system
- Star Trac's popular personal fan for comfort
- User weight capacity 350 lb (159 KG)
- Contact and telemetry heart rate



Overall Weight
185 lb (84 KG)

Width
26" (66 cm)

Length
66" (168 cm)

Height
53" (135 cm)

CONSOLES AND PVS



15.6" LED



CONNECTED PERFORMANCE

SECTION 6





OPENHUB™ CARDIO CONSOLES

When we set out to create the OpenHub display family, the objective was to provide the best technology solutions possible for our customers. As we began, a couple of simple insights surfaced: first, gym-goers carry their personal devices with them and they want to use them; and second, with the breadth of potential solutions technology can provide, there is no way a single company can be the expert in all of them.

These understandings shaped our philosophy: support personal device usage, and deliver world class technology solutions by partnering with Experts. The Star Trac and StairMaster OpenHub displays are the result.

In physical design, we made sure the displays have convenient and functional locations to place devices, capability to charge them, and connection options to integrate them into the workout experience. In hardware and software design, we created a completely open platform that includes a suite of connectivity options. Bluetooth, Wi-Fi, HDMI, NFC, RFID, ANT+, CSAFE – the OpenHub system can connect with expert partners in any way necessary to provide ideal solutions for our customers.

We utilize expert partners to provide solutions across the board: workout data tracking, interactive workout Apps, TV tuners, IPTV, asset management, streaming media, wireless audio receivers, add-on PVS, and more.

Whatever you are looking for from technology, OpenHub is there to support you and your business. For now and into the future.

ENTERTAINMENT OPTIONS

SET TOP BOX (STB) CONTROL

Connect to IPTV, satellite or cable services with our STB Ready embedded cardio screens. The connection is seamless and user control of channel and volume is handled via integrated controls on the display. No add-on keypads required. Any STB in the world. Simple.

LEADERBOARD CONNECTIVITY

Get visual feedback, coordinate engaging competitions and motivate members by connecting OpenHub to leaderboard systems.

WIRELESS AUDIO RECEIVER

Optional Integrated 800/900 MHz wireless receivers have worldwide system compatibility and provide audio from any ceiling or wall mounted TV. (Requires wireless audio transmitter)

ADD-ON PVS KIT

All of our 4, 8, 10 and S Series cardio products are pre-wired to accept an add-on 15.6" HD Personal Viewing Screen. The PVS mounts seamlessly to the product and 8/10 Series cardio includes an integrated control keypad inserted into the front of the cardio display for easy control.

8 AND 10 SERIES SPECIAL FEATURES

WEARABLE DEVICE CONNECTIVITY

NFC Technology in the OpenHub LCD and 16/20" consoles allow simple tap to pair connectivity with Apple Watch and Samsung Galaxy watches, for real-time data sharing.

QUICK KEY SELECTION

Quickly adjust speed and incline with the easy Quick Key selection on the 8-TRx and FreeRunner treadmill LCD displays. Members can quickly navigate the treadmill controls and adjust their workout with a row of large buttons on the display. This user-friendly feature allows for easy adjustment to the workout while in motion. The embedded OpenHub displays include a customizable Quick Key view for every type of equipment. .





Connects to
Apple Watch



SAMSUNG
Galaxy Watch



PVS ADD-ON

QUICK KEY SELECTION

ASSET MANAGEMENT

ECOFIT® asset management solutions let you see beyond the basics of which machines are most used – you’ll get insights that show you if you should rotate machine placements to improve maintenance scheduling, identify and plan preventative maintenance to ensure equipment is available to members and much more.

PERSONAL DEVICE STREAMING

Our 8 16/20” embedded consoles allow users to stream content from their personal device to the screen. Social Media, Streaming Media, users can enjoy all of their personal content on the big screen without the need to enter personal password information into a public device. This requires an HDMI connection to our integrated HDMI port using a cable appropriate for a user’s personal device, be it Apple®, Android™ or other. (Cables not included)

HUB CAP - OPTIONAL TABLET HOLDER

For viewing content on a personal device while exercising, we offer a tablet holder add-on kit that integrates to the top of our LCD consoles. It’s able to hold tablets up to 10.1” diagonal screen size.

OPENHUB™ PROGRAMS

EXCLUSIVE HIIT PROGRAMS

OpenHub embedded consoles offer an exciting and innovative HIIT program developed by World Record Holder, Olympic Trials Qualifier and Master Instructor, Sonja Friend-Uhl. Interval training has been clinically proven to provide amazing benefits, such as reducing blood pressure, glucose sensitivity and body fat, while improving aerobic fitness and muscular power. A version of the program was created for each piece of cardio equipment, with time-efficient workouts that take only 20 minutes to complete and can be adjusted to work for any fitness level. Variations allow for hundreds of different workout combinations, keeping participants engaged as they progress through the ranks to higher effort levels. Get maximum benefits from your cardio workout with 90% less training volume and up to 67% less time commitment compared with other interval training protocols.

RUNTV

Available on Star Trac consoles, RunTV is an immersive fitness entertainment experience designed to help motivate you to get the most from your exercise. Gain access to a curated collection of virtual environments to run through and empowering videos to watch as you workout. Take on the Tour de France, watch videos on improving your technique, get inspired by stories of extraordinary human feats, or lose yourself in a feature film. Whatever you choose, RunTV will empower you on your journey.

OVERDRIVE TRAINING MODE

An entirely new climbing experience – StairMaster 10G OverDrive simulates carrying and pushing a load while climbing stairs. Users choose either manual control or one of several pre-programmed interval workouts in the OverDrive Training Mode. Overdrive creates the toughest workout ever delivered on the cardio floor. Push to accelerate the steps and increase your work load, stop pushing to recover. The most demanding StairMaster workout. Ever.

LANDMARK CHALLENGE

The StairMaster Landmark Challenge lets you test yourself against various landmarks. See if you can climb the Eiffel Tower, the Empire State building, the Burj Khalifa, or one of many other landmarks selected from all over the globe.

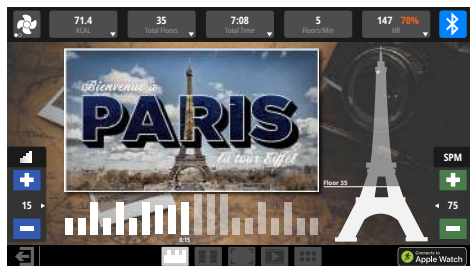

CONSOLE FEATURES/AVAILABILITY

	16"/20" EMBEDDED	LCD
BLUETOOTH DATA TRACKING/ANT+	●	●
APPLE GYMKIT AND SAMSUNG GALAXY WATCH CONNECTIVITY	●	●
BLUETOOTH HR AND HEADPHONES	●	
USB CHARGING PORT	●	●
WI-FI / ETHERNET	●	
PERSONAL DEVICE STREAMING VIA HDMI	●	
PERSONAL FAN	●	●
TV TUNER (GLOBAL)	○	○
ADD-ON PERSONAL VIEWING SCREEN		○
IPTV / SET TOP BOX CONTROL	○	○
800 / 900 MHZ RECEIVER		○
FREE WORKOUT CONTENT (RUNTV)	●	
EXCLUSIVE HIIT PROGRAMS	●	
INTEGRATED SERVICE INDICATOR	●	●
EGYM 5* COMPATIBLE	●	
ECOFIT ASSET MANAGEMENT	○	○
CUSTOMIZABLE HOME PAGE GRAPHICS/LOGO	●	
CUSTOMIZABLE USER APP LIST	●	

TABLE KEY: ● INCLUDED ○ OPTIONAL

OUR EXPERT PARTNERS



FitMetrix, Broadcastvision Entertainment, ECOFIT, EGYM, MYE, Performance IQ, Zwift, Runsocial, Apple and MyZone are registered trademarks and/or service marks owned by other companies not affiliated with Core Health & Fitness LLC and are not owned by Core Health & Fitness LLC.

wexer

As a digital fitness market leader, our mission at Wexer is to make world-class exercise accessible to more people by harnessing the power of technology, while simultaneously ensuring traditional facilities remain at the very heart of the fitness experience.

SECTION 7



FITNESS ANYWHERE

WHAT WE'RE KNOWN FOR

Customized Partner Solutions

World-Class Content

Ongoing Reliability

Innovation and Evolution of Technology

Trusted Partner



wexer

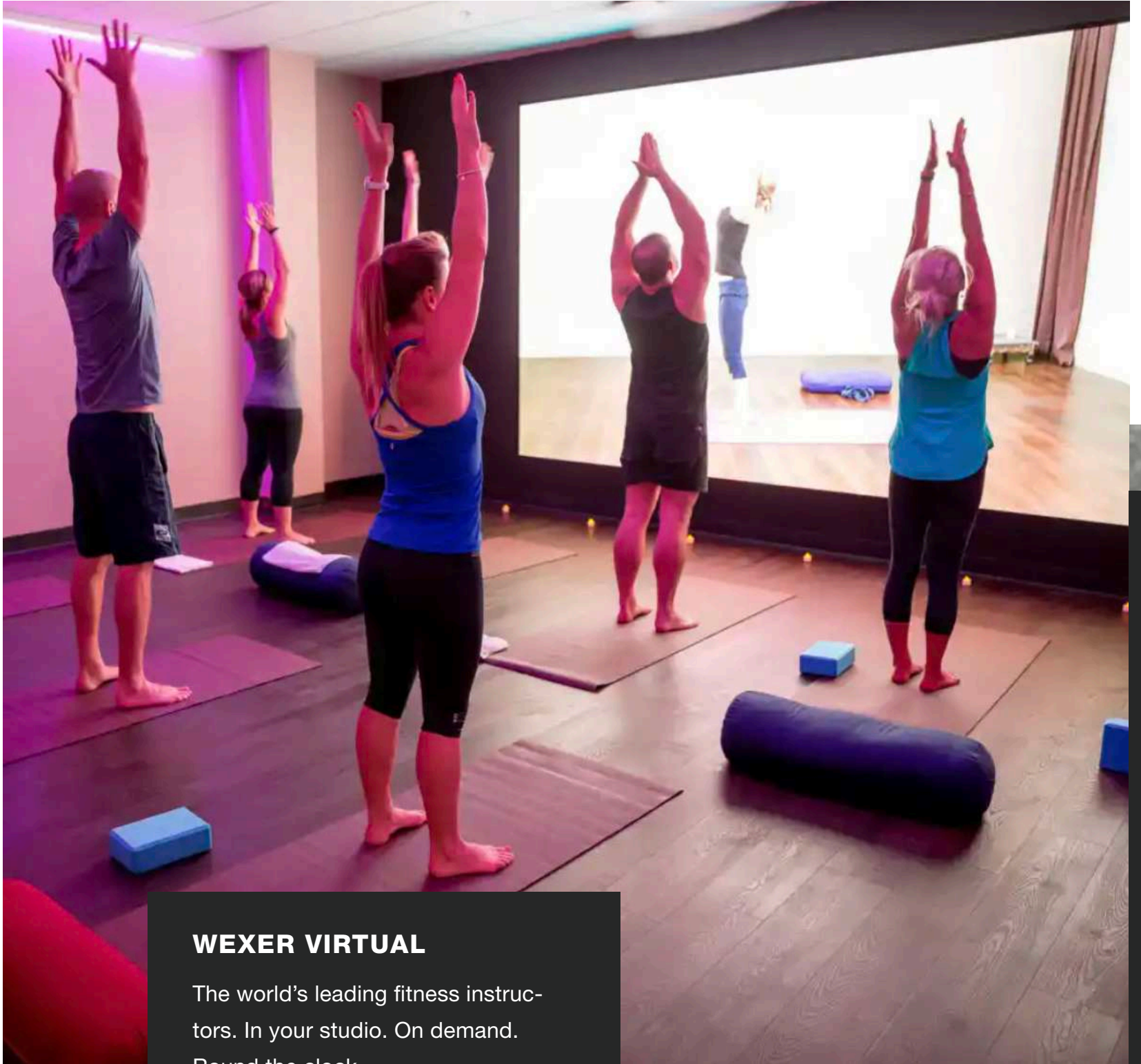

WEXER VIRTUAL

The world's leading fitness instructors. In your studio. On demand. Round the clock.

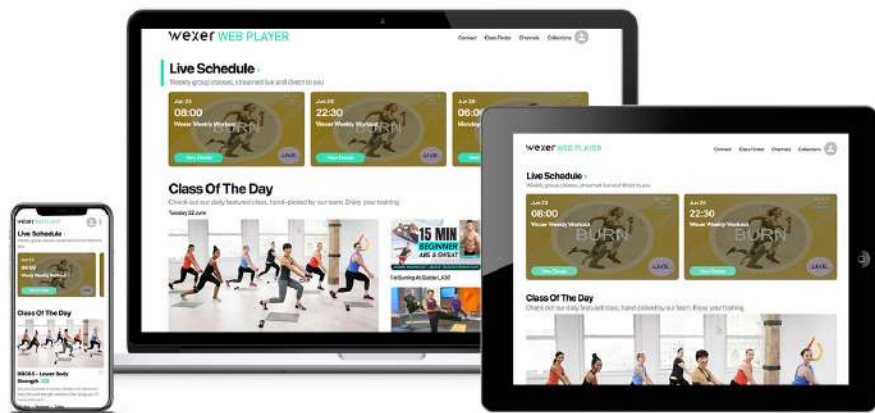

WEB PLAYER AND APP

The Wexer Web Player is a white-labeled, web-based product that allows your members to stream exercise classes and content to any internet-enabled device, 24/7.

WEXER SDK/API

The Wexer API and SDK unlock the content that resides in the Wexer ecosystem – the world-class content that we curate from our global content partners – so it can be extracted and dropped into your own digital ecosystems.

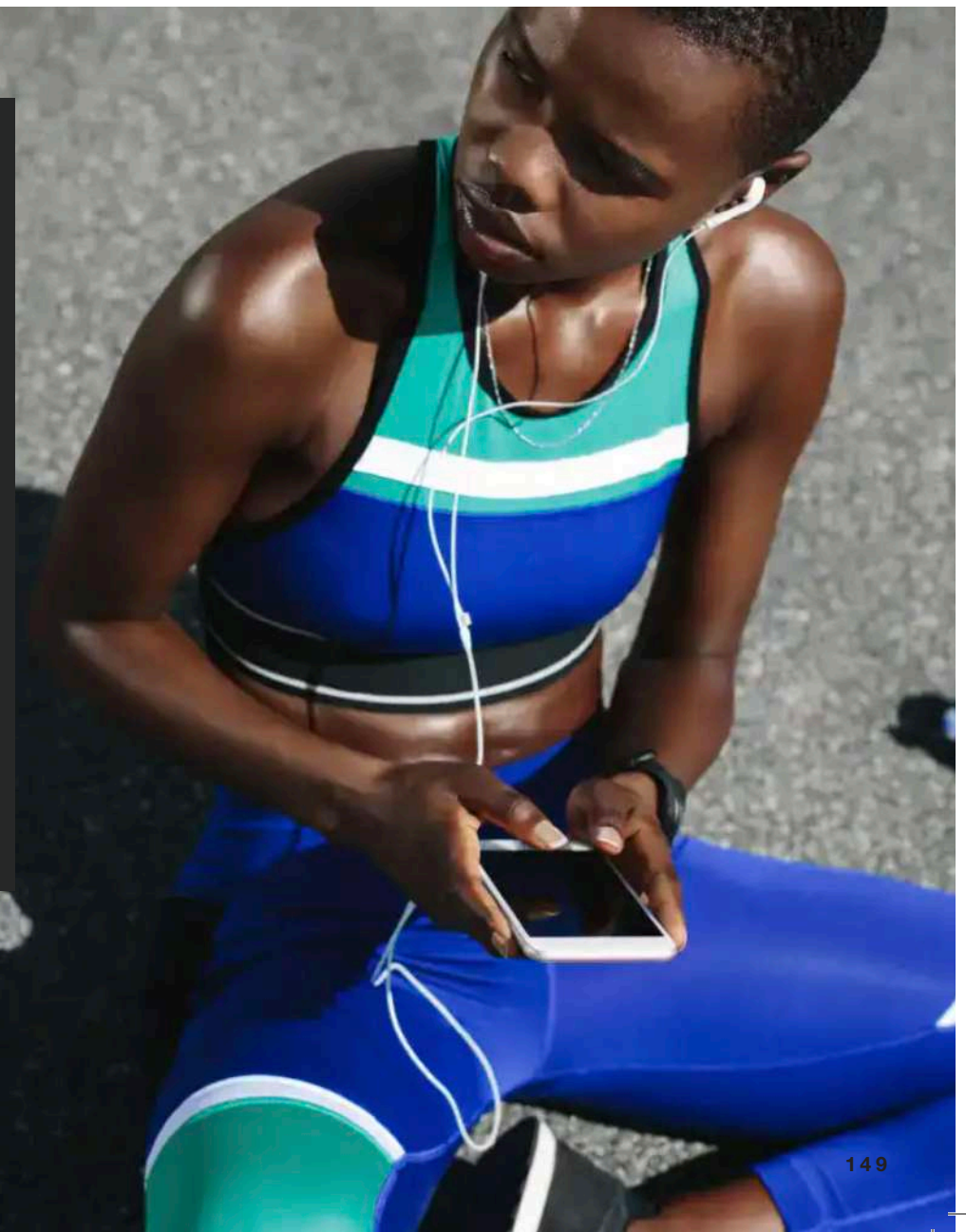



SCHWINN[®]

RIDE AS ONE

With historic roots in outdoor cycling, Schwinn's focus has always been on authenticity and quality. We brought the feel of the road to indoor cycling with the same expertise and education that drives the industry forward. Schwinn is an informational and educational source for all things Indoor Cycling.

SECTION 8



RIDE AS ONE

WHAT WE'RE KNOWN FOR

High quality products

A brand members are proud to use

Products are ergonomically designed for proper movement

A reliable brand

Makes products that are fun to use

A reputable, trustworthy company





SCHWINN

RIDE AS ONE

THE Z BIKE

Powered by quantifiable metrics, accountability and an instructor who will push riders to be their best; the Schwinn Z Bike is for studios that focus on quantifiable metrics.

Featuring our Zone Console, the Z Bike's simplified design takes the intimidation out of power training by equalizing effort across a class. The LED located on the forks syncs with the rider's zone, giving the instructor a visual queue to coach. If zone's aren't your thing, instructors can choose to simplify the display with a reduced mode that turns off the zone training. But you can still light up the studio by selecting a static color mode that suits your mood...or your brand.

And whether you yearn for the feel of a road bike or the whisper-quiet smooth experience of an indoor bike, Schwinn's drive trains have been built to last. Both the Poly V and Carbon belts are engineered to be durable, tension-resilient and maintenance free. Choose the feel that will keep your members riding; Za for an authentic road feel or Zs for a smooth ride.

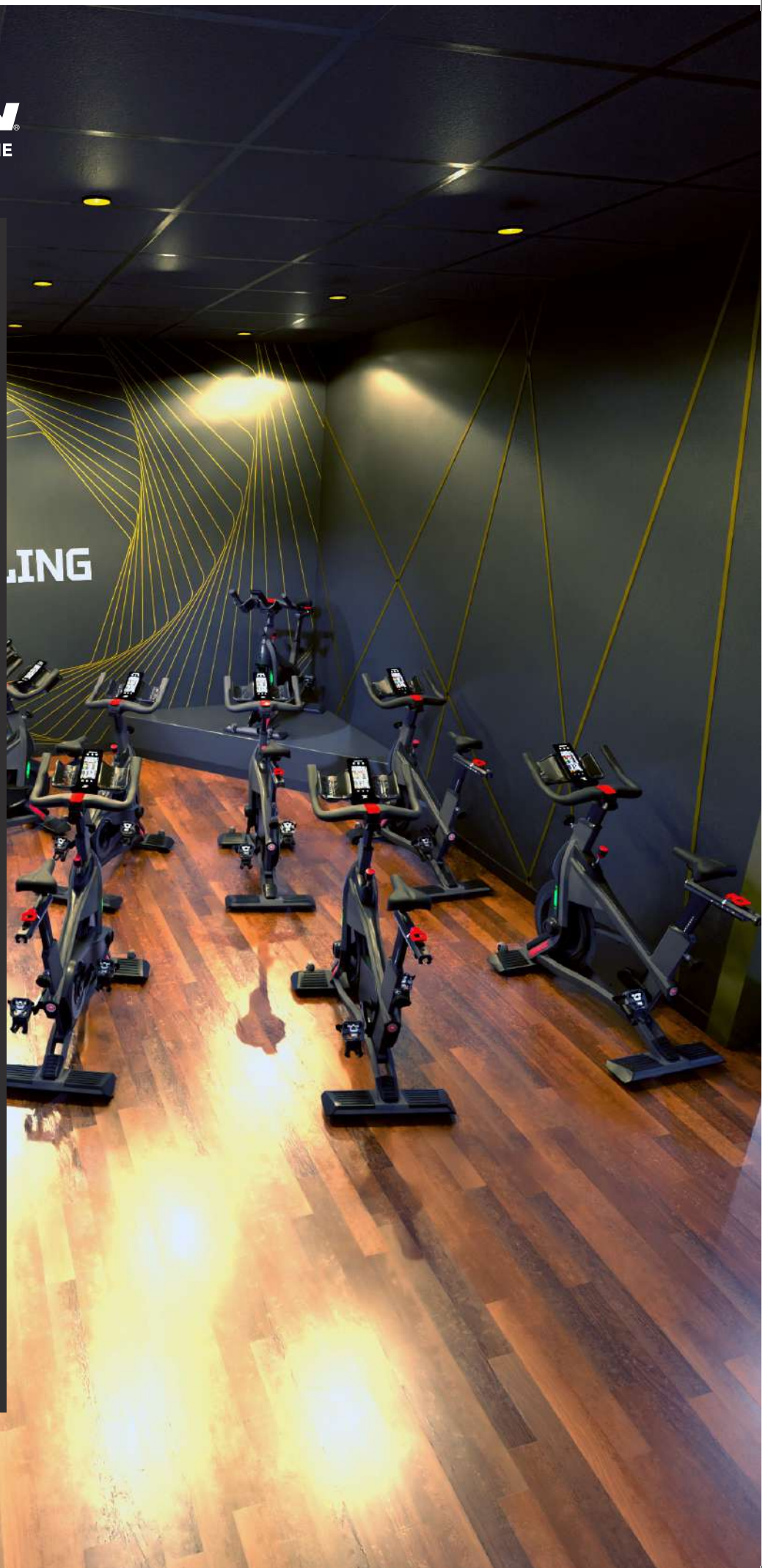



THE X BIKE



The Schwinn X Bike is for studios that focus on the experience. With zero on-board technology, the X Bike focuses on the instructor guided journey and invites the rider to come along for the ride.

And whether you yearn for the feel of a road bike or the whisper quiet smooth experience of an indoor bike, Schwinn's drive trains have been built to last. Both the Carbon and PolyV belts are engineered to be durable, tension-resilient and maintenance free. Choose the feel that will keep your members riding; Xa for an authentic road feel or Xs for a smooth ride.

SMARTER. FASTER. SAFER.



Using patented 3D strain gauge technology, the 4iiii crank delivers accurate, reliable and consistent data. Trusted by the best athletes in the world, the same technology is now available to indoor riders. Whether it's tracking calories or in-depth power analysis, the 4iiii crank offers accurate results to help riders reach their full potential.

- Accurate within <1%
- Bluetooth Smart and ANT+ provides reliable connection to leaderboards, personal tracking apps, sport watches and consoles
- 1500 hours of battery life via 2 standard AA batteries

INSTRUCTOR TRAINING



In an ever-changing, global community it is important to meet our customers where they are. This is why we offer 3 ways for instructors to access our educational content. With On-line (Remote Self-paced), Live Stream/Virtual, and Live/In-Person training options, instructors can enhance and upskill their coaching styles and elevate the member experiences.

[SEE PAGES 152-157 FOR MORE ON OUR EDUCATION OFFERINGS](#)



SCHWINN

RIDE AS ONE

THE Z CONSOLE

Group Cycling unites a diverse array of people seeking an elevated level of training and motivation. Our Z Console is uniquely qualified to meet the challenge. Powered by Schwinn Zone Training, instructors will love uniting a class with color, allowing members at both ends of the fitness spectrum to ride side by side with the same intensity, sense of accomplishment.

Schwinn's broad-based approach reduces the traditional number of Power and Heart Rate training zones to 4 to align with ratings of perceived exertion, creating more accessible and attainable programming for instructor and member alike. Zone-colored LED lights next to the flywheel displays each member's intensity, encouraging the class to Ride As One.



KEY FEATURES

The integration of product and education means award-winning Master Instructors live inside each and every bike and the technology featured in our Z Console offers something for everyone.

Screen configuration allows instructors to get creative with class design; offering a more diverse and specialized schedule to members. Tying metrics to colors and recognizable graphics; instructors and members can focus on their goal at hand.

Built for growth, the Z Console is designed for progress and loaded with new tools to discover every class. Tools like FTP trophies to track personal best and fusion timers that challenge instructors to get creative with programming concepts.



SCHWINN JOINS THE OPENHUB™ FAMILY

When we set out to create the next generation of group-cycling bikes, one goal was to provide the best technology solutions possible. To do this, we knew we had to partner with the best tech companies in the industry. Schwinn has joined Star Trac and StairMaster and created the Z Console as an OpenHub console, making pairing with Bluetooth, ANT+ or NFC easier than 1, 2, 3.

Whether you're a gym owner looking to elevate your member experience or an instructor setting goals for your riders, Schwinn and our partners have technology solutions to help you succeed.

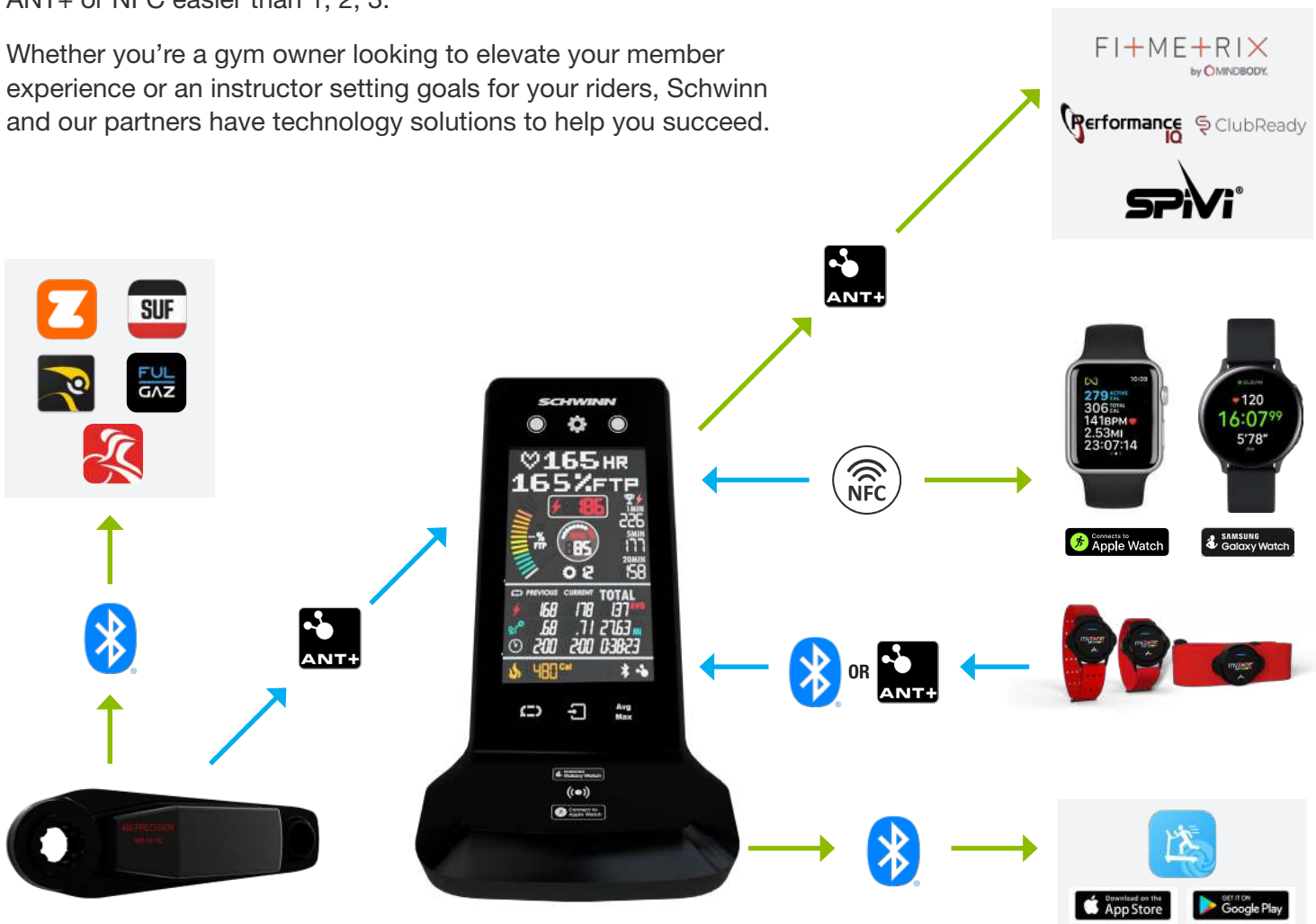

This diagram includes examples for each connection type but is not limited to the options shown.

Zs Bike 9-7510

- Smooth Poly V Drive Train
- 4iiii® crank arm powermeter delivers accurate strain gauge power feedback to help riders train harder and smarter
- 6 Magnet Non-Contact Magnetic Resistance System
- Morse Taper pedals and bottom bracket for increased durability and reliability
- Frame Finish – Powder Coated Aluminum
- Zone Console Included



Overall Weight
130 lb (59 KG)

Width
20.6" (525 mm)

Length
42.5" (1076.5 mm)

Za Bike 9-7520

- Authentic, Toothed Carbon Belt
- 4iiii® crank arm powermeter delivers accurate strain gauge power feedback to help riders train harder and smarter
- 6 Magnet Non-Contact Magnetic Resistance System
- Morse Taper pedals and bottom bracket for increased durability and reliability
- Frame Finish – Powder Coated Aluminum
- Zone Console Included



Overall Weight
130 lb (59 KG)

Width
20.6" (525 mm)

Length
42.5" (1076.5 mm)

Xs Bike 9-7480

- Smooth Poly V Drive Train
- Integrated phone/tablet holder
- 6 Magnet Non-Contact Magnetic Resistance System
- Morse Taper pedals and bottom bracket for increased durability and reliability
- Frame Finish – Powder Coated Aluminum



Overall Weight
130 lb (59 KG)

Width
20.6" (525 mm)

Length
42.5" (1076.5 mm)

Xa Bike 9-7470

- Authentic, Toothed Carbon Belt
- Integrated phone/tablet holder
- 6 Magnet Non-Contact Magnetic Resistance System
- Morse Taper pedals and bottom bracket for increased durability and reliability
- Frame Finish – Powder Coated Aluminum



Overall Weight
130 lb (59 KG)

Width
20.6" (525 mm)

Length
42.5" (1076.5 mm)

AC™ Sport 9-7340

- Carbon Blue™ durable toothed drive train provides an Authentic Cycling experience
- Magnetic Resistance Brake for zero drive train maintenance
- Optional 4iiii® crank arm powermeter delivers accurate strain gauge power feedback to help riders train harder and smarter.
- Optional Echelon2 Console provides immediate feedback to help riders train with results
- Morse Taper pedals for increased durability and reliability
- Schwinn Fit System enables versatile seat and handlebar adjustments for refined positioning
- Frame Finish - E-Coated & Powder Coated Steel
- Seat Slider, Handlebars, Hardware Materials - Stainless Steel



Overall Weight
115 lb (52 KG)

Width
20" (51 cm)

Length
50" (127 cm)

Height
50" (127 cm)

SC5 9-7410

- Heavy Perimeter-Weighted Flywheel and quiet Poly-V belt Drive Train provide an Smooth Cycling experience
- Direct Pressure Brake Resistance
- Optional 4iiii® crank arm powermeter delivers accurate strain gauge power feedback to help riders train harder and smarter.
- Optional Echelon2 Console provides immediate feedback to help riders train with results
- Morse Taper pedals and bottom bracket for increased durability and reliability
- Multi-position handlebars accommodate a wide range of choreography
- Find your perfect riding position with easy micro seat and handlebar adjustments
- Frame Finish - E-Coated & Powder Coated Steel
- Seat slider and handlebar materials - Aluminum



Overall Weight
134 lb (61 KG)

Width
21" (53 cm)

Length
55" (140 cm)

Height
46" (117 cm)

IC Classic 9-7420

- Chain drive using forged steel crank and ISIS oversized bottom bracket
- Heavy Perimeter-Weighted Flywheel
- Direct Pressure Brake Resistance
- Narrow Q-Factor
- Optional Cadence Pro Console
- Trapezoidal seat adjustment
- Frame Finish - E-Coated & Powder Coated Steel



Overall Weight
114 lb (52 KG)

Width
20" (51 cm)

Length
43.5" (110 cm)

Height
46" (117 cm)

COMPATIBLE USER RANGE

Max User Weight

(X and Z Bikes)

300 lb (136 KG)

(AC Sport, SC5, IC Classic)

350 lb (159 KG)

User Height Range

(All Bikes)

4'11" to 6'8" (150 cm to 203 cm)



SCHWINN

RIDE AS ONE

YOUR RIDE YOUR WAY





CUSTOMIZATION

We know what it takes to build an authentic, meaningful brand experience. Our customization program is the perfect way to leverage all that hard work into creating an amazing group cycle experience. Whether your goal is creating a tranquil place to unwind or a high-energy disco ball clad club scene, our consultative approach will get you there.



Adding your logo can elevate a members' ride by immersing them into your brand experience. Decal placement options allow you to pick and choose what fits for your brand needs. Plus, we offer 19 colors that are sure to make your vision come to life. Let us design the right bike for you!



Triple Link pedals give users the freedom to choose between strapping in with the use of toe cages or using cycling shoes with pedal options for SPD® and Keo or SPD and Delta® compatible clips. Our pedals use a patent-pending threadless spindle that virtually eliminates the potential for the pedal spindle to break or back out of the crank. With easy installation and worry-free performance, we think it's the best thing to happen to pedals since the clip.



With optional accessories like Numbering Tags and Dumbbell Holders studios are able to get the most out of their bikes and maximize class variety.

EDUCATION

SECTION 9





CREATING LEADERS IN FITNESS

At Core Health & Fitness we believe that knowledge is power. With the world's greatest Master Instructors, we create the most personal, accessible and innovative instructor education programs available in the industry. With our award-winning teams, instructors can earn continuing education credits backed by global accreditation organizations like ACE AFAA, CIMSPA, NASM and REPS. Our courses transform passionate enthusiasts into thoughtful, empowered and skilled experts.

Your instructors can become certified in a variety of fitness programs including High Intensity Interval Training (HIIT), Indoor Cycling, BoxMaster, Strength Training and Cardio Training; helping you launch or optimize revenue generating programs.

By offering a robust selection of quality fitness programs and world class instructor training, we give facilities the opportunity to upskill their teams, expand their member base, retain existing members and open up new revenue opportunities. We are committed to developing cutting-edge programming and providing tools that can help any instructor elevate their teaching performance and member experience.

We also know, in an ever-changing, global community it is important to meet our customers where they are. This is why we offer 3 ways for instructors to access our educational content:

- 1. ONLINE (REMOTE/SELF PACED LEARNING)**
- 2. LIVE STREAM/VIRTUAL**
- 3. LIVE/IN PERSON**

EDUCATION OFFERINGS

ONLINE: REMOTE/SELF PACED LEARNING COURSES

Hosted on Inspire360.com, our Online Courses are self-paced and pre-recorded, allowing instructors to sign-up for and complete a course at their own pace. They are crafted in modules so that content can be watched in one sitting or incrementally, and each module is followed by a short quiz. Once the course has been completed and final exam passed, a certificate of completion including continuing education credits is attached. Once certified there are no additional requirements to maintain certification.

- Schwinn Classic Certification
- Schwinn Performance and Periodization Workshop
- HIIT Functional Training Certification by StairMaster
- Strength Training Specialist Training Program by Nautilus
- Cardio Coach Specialty Training Course by Star Trac

[INSTRUCTORS CAN REGISTER AT COREHANDF.INSPIRE360.COM](https://www.corehandf.com/inspire360)

LIVE: VIRTUAL LEARNING

Virtual Learning opportunities are events managed by Core or as part of fitness conventions with whom we partner, such as SCW, DCAC, PNW, IDEA or canfitpro. These virtual events do not require access to fitness equipment and our coaching principles, while written specifically for a particular modality, apply to all formats of coaching!

Our virtual ride or workout demos offer attendees an amazing opportunity to hyper-focus on the coaching, cueing, and execution of the experience created by our Master Instructors; allowing attendees a unique perspective to see how the coach really impacts the class. Workshops and Certifications offered:

- Schwinn Classic Instructor Program
- Schwinn Power Instructor Program
- Schwinn Indoor Cycling Workshops - take deep dives into specific subject matter or trends
- Hybrid 2-Day Schwinn Certification (Only available in EMEA Region)
- HIIT Instructor Program by StairMaster
- Strength Training Specialist Training Program by Nautilus
- Cardio Coach Specialty Training by Star Trac
- BoxMaster Training Program

[REGISTER FOR EVENTS IN YOUR REGION BY VISITING COREHANDF.COM](https://www.corehandf.com)



EDUCATION OFFERINGS

LIVE: IN-PERSON CERTIFICATIONS AND WORKSHOPS

Live, In-Person opportunities are events managed by Core and can be part of a fitness convention with whom we partner, such as SCW, DCAC, PNW, IDEA or canfitpro. We also offer facilities and clubs the opportunity to host an on-site training day. Providing a personal training day for their instructor teams while providing an opportunity to recruit new team members. Our Live In-Person Certifications cover multiple fitness modalities and offer an interactive, in-person memorable and empowering experience.

- HIIT Functional Training Certification by StairMaster
- Strength Training Specialist Training by Nautilus
- Cardio Coach Specialty Training Course by Star Trac
- Schwinn Performance and Periodization Workshop
- Schwinn Classic Instructor Program
- Schwinn Power Instructor Program
- Hybrid 2-Day Certification (Only available in EMEA Region)
- Schwinn Indoor Cycling Workshops that take deep dives into specific subject matter or trends

[REGISTER FOR EVENTS IN YOUR REGION BY VISITING COREHANDF.COM](https://corehandf.com)

At Core, we put great value on instructor education, this is why we offer training programs for each one of our Brands; StairMaster, Throwdown, Nautilus, Star Trac and Schwinn. The training opportunities elevate your Instructors ability to bring your facilities to life. To learn more, visit corehandf.com/certification



CORE

HEALTH & FITNESS

CUSTOMER SERVICE

Support is more than just something we offer, it's what we do best. We proudly offer world-class services to more than 90 countries around the globe with a team that truly partners with you to support all of your service needs, both pre and post-sale. In the end, our goal is to keep your facility operating at maximum capacity with little equipment downtime.

SECTION 10



CORE CONNECT

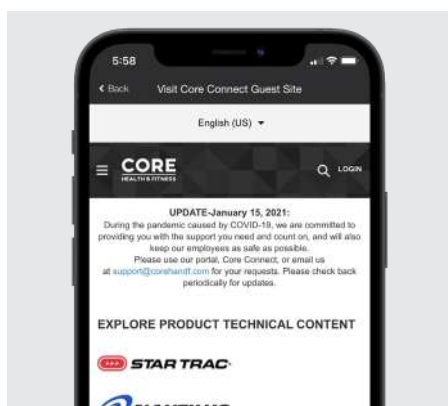

Get world class support for all of our brands with our Core Connect portal, a platform that simplifies the process for warranty registration, preventive maintenance, service requests, parts orders and allows you to get help with your general inquiries.

SCAN TO DOWNLOAD CORE CONNECT APP



APPLE APP STORE



GOOGLE PLAY

CORE ADVANTAGE



Our preventative maintenance program, Core Advantage, will help preserve your equipment as excessive use takes its toll and ensures the longest possible life of your products while reducing downtime. We offer programs for all aspects of gym equipment, in every category and for every Core Health & Fitness brand. Core Advantage provides the industry's most complete programs; including one-time, semi-annual, and quarterly options.

BENEFITS OF CORE HEALTH & FITNESS CUSTOMER SERVICE

connect.corehandf.com for preventative maintenance schedules, owner's manuals, and other online support

Customer Support Center offering live chat and phone support from 6am to 5pm PST

Network of 600+ factory-trained, annually-certified service providers

In-service seminars for staff

SCAN THE QR CODE ABOVE TO LEARN MORE ABOUT OUR WORLD-CLASS CUSTOMER SERVICE

FOLLOW US ON SOCIAL MEDIA

Core Health & Fitness



StairMaster



Schwinn



Nautilus



Star Trac



Throwdown



Wexer



GLOBAL SUPPORT CENTER

4400 NE 77th Avenue, Suite 250
Vancouver, WA 98662
Tel: +1(888) 678-2476

GLOBAL INNOVATION CENTER

20 Empire Drive
Lake Forest, California 92630
Tel: +1 (800) 228-6635

EMEA SUPPORT CENTER

Unit 4, The Gateway Centre, High Wycombe
Buckinghamshire HP12 3SU
Tel: +44 (0) 1494 688260

ASIA PACIFIC

25 North 2nd Road
Xinglin, Jimei District
Xiamen, China 361022
Tel: +86 (0) 592 624 8296

GERMANY

Fraunhoferstr. 22
82152 Planegg, Germany
Tel: +49 89 2189800

POLAND

Unit 4, The Gateway Centre, High Wycombe
Buckinghamshire HP12 3SU
Tel: +34 934808540

BRAZIL

Rua São Luiz Gonzaga, N. 1791, suite 1817
Benfica, Rio de Janeiro, 20910-065, Brazil
Tel: +55 (19) 3837 3047